

Construction and Business Plan

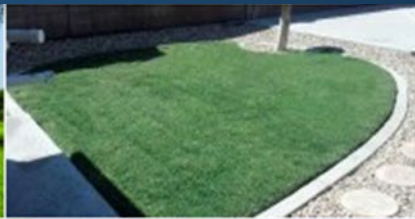

Introduction.....	4
Construction of the facility	8
The Project Management Institute (PMI) methodology as outlined in the PYMBOK.....	8
Value Improvement Practices –	8
Summary of Construction Management Plan.....	8
Executive Project Director of Construction.....	9
Project Design, Permitting and Life Safety	12
Equipment, Integration, AND Controls,	12
Procurement – Illinois EPA Air Permit.....	18
Air Compliance.....	18
Base Building Architectural, Structural MEP, and Life Safety	24
Financial Models, Operating Budgets and the Capital Budget.....	28
Financial Considerations and Project Requirements	28
The Volume of Biosolids Accepted	28
Start-Up Capital Requirements:.....	28
Property Requirements.....	28
Seasonal Demands.....	28
Storage Needs.....	28
Labor	28
Insurance	28
Marketing and Sales Considerations.....	28
The Financial Model Option-1 May Start, December Production.....	29
Option-2 August Start, June Production	31
Financial Modeling Assumptions	33
The following are the Assumptions Seasonal Demands used in formulas	35
The following are the Assumptions for Production Rates and Crew costs used in formulas	36
The following are the Assumptions for Bagging Machine Rate and Crew Sizes used in formulas.....	37
The following are the Assumptions for Labor Costa and Burdens used in formulas.....	38
The following are the Assumptions for Electrical Costs used in formulas	40
Sales and Marketing Plan.....	45
Site One Landscape Supply	47
EWING Irrigation & Landscape Supply.....	47
Home Depot With 2285 – Locations Nationwide.....	48
Rural King Supply With 116 – Locations Nationwide	48
Tractor Supply With 1,181 – Locations Nationwide.....	48
Menards With 316 – Locations Nationwide	49
Mid-States Distributing small and medium rural farm stores With 700 – Locations Nationwide	50
A.G. Processing #5 Farm co-op in the U.S.....	50
Inventory and Warehouse Controls	52
IT and Communications Systems	52
Logistics.....	54
Warehouse and Logistics Management.....	55

<i>Production Monitoring and Endpoint data collection</i>	55
<i>Local Security Systems</i>	56
<i>Project Close-out</i>	56
<i>Exhibits:</i>	59
Exhibit - A Equipment	60
Blending Line	61
Bagging/Palletizing/Shrink-wrap Line	76
Air Quality Control - Odor and Dust Control.....	110
Integrated Controls.....	115
Small Equipment CapEx	116
Pallet Racking System	119
Exhibit - B Improvements to The Structure	122
Exhibit – C Drawings – Design/Development	123
Exhibit - D Schedule	145
Exhibit - E Safety	147
Safety – Design and Construction	147
Safety - During Normal Operations.....	147

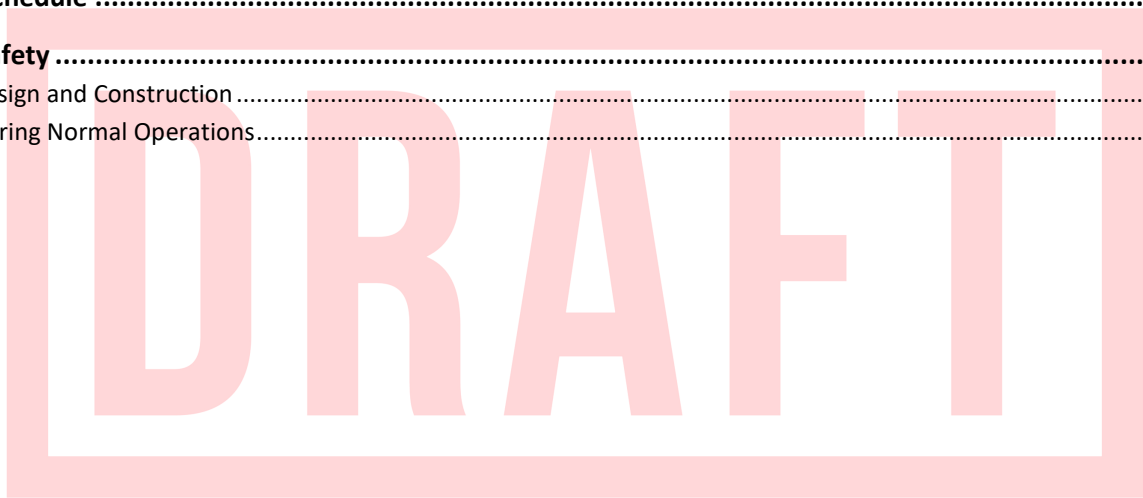

Introduction

Iliana Blending and Bagging, LLC (the Company) is a new Indiana limited liability organization intended to own and operate a plant designed for custom blending and sale of soil products, primarily organic fertilizer, to retail markets and landscaping and turf growing and maintenance contractors.

The principal output of the plant is intended to be a patented brand of organic fertilizer – Nutri-Pel

The Company will construct, equip, and operate the business of blending, packaging, and shipping its products. It is intended to be owned by seasoned manufacturing and construction materials processors and engineers as well as by -----

The Company's significant shares are all held by individuals with unique skills and long-term roles in its success:

Joseph A. Volini, Company President, the current owner of a construction materials business with a twenty-years experience in materials handling and business management

Bart R. Lynam, Company Vice-President and COO whose background includes 40 years of project development, engineering, and construction, including supervisory positions in two INR 100 national construction companies

Thomas A. Volini, Board Member and advisor to the Company, former Chairman and COO of Continental Waste Industries, Inc (NASDAQ, CWI)

Bart T. Lynam, engineer and Company consultant formerly General Superintendent of the Metropolitan Water Reclamation District of Greater Chicago

During the plant construction and commissioning process, the Company will distribute and sell bulk shipments of the organic materials to agricultural and turf supply/maintenance contractors in Illinois, Indiana, and Ohio. The commissioning of the plant will enable the incorporation of these same two organics (more than 50% of the product) into ----- . Other components consist of inorganic chemicals stored in the plant and custom blended, bagged, and shipped directly to retail stores and, in larger bags, to turf contractors. All blending, bagging, storage and shipping of this product will be accomplished at the plant site by the Company. Marketing of the finished product will be primarily through Nutri-Pel, supplemented by the Company itself.

The Company plans to enter into a long-term supply contract with the distributor of a major player in sludge drying (Veolia Water, North America), providing for the acquisition of organic materials from one of the largest wastewater treatment plants in the world, the Stickney, Illinois plant of The Metropolitan Water Reclamation District.

-----production will commence as early as January 2022 or as late as April of that year. The attached financial projections demonstrate a closing on financing (assumed May 2021) until the ramp-up of ----- production and sales over eight years. Low-grade biosolids for agricultural application and turf grass command an average price of \$73-82 dollars per ton, while -----is projected to sell initially for \$600 per ton. Over a period of time, the customer mix is intended to shift to the retail and direct fulfillment marketplace where smaller quantities marketed to homeowners and smaller institutions can command more than double this pricing.

The Benefits of Biofertilizer

- Biofertilizer is environmentally sustainable, which results in reduced consumption of fossil fuel products.
- Biofertilizer reduces the carbon footprint of greenhouse gas emissions, one of the significant hazards associated with the manufacturing of chemicals with fossil fuels.
- Biofertilizer produces less chemical runoff into rivers, streams, and lakes.
- Biofertilizer produces less chemical leaching into the groundwater table.
- Biofertilizer restores normal fertility to the soil and makes it biologically more alive.
- Biofertilizer boosts the amount of organic matter and improves soil texture and structure, enhancing the soil by better retaining the water.
- Biofertilizer adds valuable nutrients to the soil.
- Biofertilizer increases the nitrogen and phosphorus available to plants more naturally than other fertilizers.
- The various compositions of the Biofertilizer product allow growers to tailor the micro-nutrients used to the particular plant needs.
- Biofertilizers are simple to use, even for small novice growers.
- Biofertilizers do not pollute the soil or the environment, whereas chemical fertilizers often result in too much phosphate and nitrogen in the soil.
- Non-farm customers apply ----- products to golf courses, residential landscapes, and corporate parks. ----- . Applied to well over one million acres in the midwestern United States OT and T (Nutri-Pel) has upcycled a quarter-million tons of organic waste.
- The fertilizer industry is expected to grow to 2.7 billion by 2027, expanding at a CAGR (Compound Annual Growth Rate) of 12.8%.



Partners and Key Personnel

Lorem ipsum dolor sit amet, ut munere nostro animal sea, id reque dignissim eam. Vidit tempor ridens ne eos, cu vix omnium feugait, pro menandri perpetua ei. Per etiam ridens accusata in, no vis partem consulatu. Duis mentitum ut vel.

Eu quo pericula complectitur, ei sumo sint philosophia usu. Quo delenit salutandi scripserit et. Te eam eripuit conceptam, ipsum adversarium vix et, ex eum scripta philosophia. Vidit natum ad usarolina at Chapel Hill and earned his law degree from the University of Virginia. philosophia. Vidit natum ad usu, fierent appellatur neglegentur eu mel, soleat argumentund. BA with highest honors at the University of North Carolina at Chapel Hill and earned his law degree from the University of Virginia. philosophia. Vidit natum ad usu, fierent appellatur neglegentur eu mel, soleat argumentund. BA with highest honors at the University of North Carolina at Chapel Hill and earned his law degree from the University of Virginia. philosophia. Vidit natum ad usu, fierent appellatur neglegentur eu mel, soleat argumentund. BA with highest honors at the University of North Carolina at Chapel Hill and earned his law

NUTRI-PEL *Nutri-Pel Inc. - O.T. & T. Inc.*

We now have an alternative product for you as a viable alternative to the high priced conventional fertilizers. Nutri-Pel is environmentally friendly, easy to use, and doesn't require watering in during the application stage as it will stay on the soil until it rains or irrigation activates the soil microbes that break it down into its nutrients. Nutri-Pel can be used as a complete lawn fertility program or with other products as part of your program. When you use Nutri-Pel as part of an overall program, do not over apply nitrogen fertilizer. You should be applying, depending on your location and grass type, one pound of nitrogen per application, three to six times per year. You can use Nutri-Pel for your vegetable gardens and stay at ease with children around, as it is an excellent and safe fertilizer for all plants that grow outdoors. Children and pets can safely go onto areas that have been fertilized with Nutri-Pel. Nutri-Pel can be applied in the Summer and during drought periods as the fertilizer does not contain any salts that would burn plant leaves during the dry or hot periods. Additionally, Nutri-Pel can be applied any time during the growing season and it is suitable for your climate and growing conditions.

Glen Troyer -President, Owner, Nutri-Pel Inc. - O.T. & T. Inc.

Insert Bio Here

Lorem ipsum dolor
tempor ridens ne
melius
id



sit amet, ut munere nostro animal sea, id reque dignissim eam. Vidit eos, cu vix omnium feugait, pro menandri perpetua ei. Per etiam accommodare philosophia. Usu no purto accusam, duo ancillae legendos



Joseph A. Volini - President,

Currently, Joe is a construction materials business owner with twenty years of experience in materials handling and business management. Joe has led the Initiation, Start-up, and successful operations of several large material handling ventures. Joe led the successful acquisition and permitting of the Heartland Recycling facility in Aurora, Illinois. Joe holds a law degree from Loyola University, Chicago

Bartholomew R. Lynam - Vice-President and COO



Bart's background includes 40 years of project development, engineering, and construction, including supervisory positions in two INR 100 national construction companies. Bart possesses a wide variety of construction management experience, including Industrial, hospitality, hospitals, and multi-use mid-rise to high-rise buildings. Bart holds a B.S. in Civil Engineering from the Illinois Institute of Technology. His early years were spent with two major ENR Top 50 firms, which afforded him a solid foundation in the building industry. Subsequently, Bart headed his own General Contracting firm for nearly twenty years before joining Midway Enterprises, Inc. out of Chicago, where he serves as Director of Company Operations.

Thomas A. Volini, Board Member and advisor to the Company,

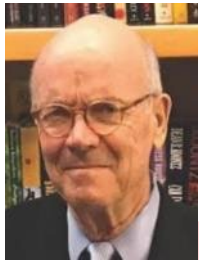

Tom, former Chairman and COO of Continental Waste Industries, Inc (NASDAQ, CWI) Tom acquired several regulated sewer and water utilities and a company providing services to other utilities in Illinois and Indiana. He also acquired Midwestern Electric, Inc. in Indiana. Mr. Volini served as vice president of numerous Midwestern subsidiaries with Waste Management of North America. Mr. Volini served on the Board of Directors of American Ecology, a Nasdaq listed firm engaged in managing hazardous and low-level nuclear waste. Tom is also a leader in numerous charitable and volunteer efforts.

Bart T. Lynam - Company Consultant



President of Bart T. Lynam & Associates, Bart T. Lynam has extensive experience in engineering research, operations, and senior management in the field of wastewater treatment. In addition, he has managerial experience in the construction industry. Mr. Lynam is a member of several professional organizations, has published extensively, and has presented technical papers at numerous international conferences. Bart has several patents relating to the heat drying of biosolids. He has testified in court as an expert in the field of wastewater treatment. Mr. Lynam received his B.S. in Civil Engineering and M.S. in Environmental Engineering from the Illinois Institute of Technology, where he taught senior engineering level courses for several years. He is a Licensed Professional Engineer, Board Certified by the American Academy of Environmental Engineers, and is a Fellow in the American Society of Civil Engineers. Mr. Lynam is a member of Chi Epsilon, a Civil Engineering Honor Society.

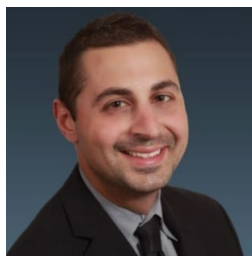

Wesley Prato - Cohn Reznick – Public Auditing Firm

Prepare audited financial statements for the enterprise.

Cohn Reznick ranks among the largest accounting, tax and business advisory firms in the United States.

From our origins in 1919, an innovative and client-centric culture has flourished at CohnReznick. We believe that this mindset defines us in many ways. First, we have an affinity for our clients — we understand your drive. Second, we recognize leadership —

talent shapes the direction of the Firm. And third, we view our success as a call to action — a means to improve our communities, promote beneficial legislative policies, and progress the high standards of the accounting profession.

With a team of over 3,000 and our extensive footprint in 25 cities with international reach through global subsidiaries and Nexia International, we can effectively mobilize to serve you on a local, regional, national, and international basis.

The breadth and depth we represent in each of our practice areas can be leveraged on demand to address your enterprise initiatives or to advance distinct opportunities.

Construction of the Facility

Management Methodologies

The Project Management Institute (PMI) methodology as outlined in the PYMBOK

[Click for full library of our PDF's](#)



Value Improvement Practices –

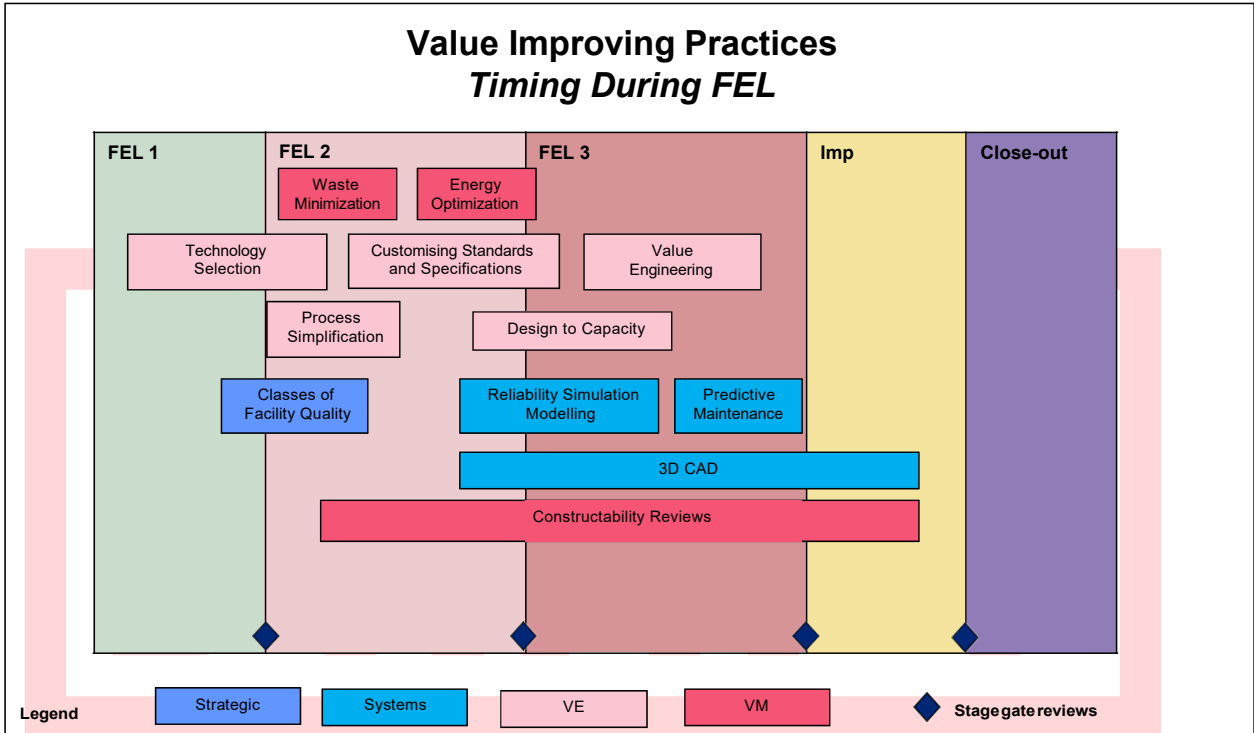

Value Methodology is a rigorous examination of what is needed (functional requirements) to meet the business objective at the least cost and eliminate non-adding investment.

[Click for full library of our PDF's](#)

Summary of Construction Management Plan

This Project Management Plan will serve as the guideline for the design, permitting, and construction of the ILIANA, LLC Blending and Bagging Facility, which will seek the approval of this Management Plan from the partnership and the Investor. All steps taken for the management and implementation of the project, including information on personnel, tasks, and schedules, must be appropriately disseminated to all key participants and the Investor.

This Project Management Plan outlines the project from design and permitting through construction completion with a smooth transition to commercial operation and marketing. An essential objective of this Plan is to develop and maintain a unified Team working environment. The size and scope of this Blending and Bagging Project may not warrant contracting to an outside Construction Manager, General Contractor, or Design-Build Contractor.

Construction Team Roles and Responsibilities

The project will consist of personnel from ILIANA, LLC who will seek approval from the Partnership and the Investor to develop the methods, policies, and procedures required for the successful construction with the completion of the project to commercial operations. (Personnel Resumes are attached).

Executive Project Director of Construction

Bartholomew R. Lynam will be the Executive Project Director ensuring professional project construction management from project inception through project close-out.

A Partial list of Bart R. Lynam's responsibilities:

- To ensure that the project's modifications to the existing building comply with the design and permit requirements.
- To prepare, monitor, and control a detailed construction budget according to the project's objectives and scope to be approved by the Partnership and the Investor.
- To prepare, monitor, and control the final construction schedule.
- To present the Partnership and the Investor with an approved list of appropriate subcontractors and their work scope, ensuring that the subcontractors are consistent with the Project scheduling needs and budget allocations.
- Monitor, control, and present monthly reports to the Partnership and the Investor on the project's cost and schedule performance.
- To prepare monthly invoices for approval from the Partnership and the Investor relating to personnel, procurement of equipment, installation, and revisions to the building in conformity with the budget line items.
- To coordinate meetings and prepare minutes, as required, relating to the progress of the construction.
- To ensure facility compliance with all of the design and operating specifications for the start-up.
- To prepare the preliminary design of the Facility to meet local, state, and federal requirements.
- To seek and engage a design firm qualified to meet all the project's design constraints and prepare all the design documents necessary for final budgets, permitting, and execution of the construction.
- To obtain the required permits by engaging the appropriate environmental firm.
- To initiate procurement for the major Blending and Bagging equipment and select subcontractors, i.e., mechanical installation, electrical, and utilities.
- To maximize the automation of the individual components to minimize operating labor costs.
- To develop a detailed preliminary construction schedule to maximize the output of the fertilizer product.
- To implement a cost management plan.
- To seek approval from the Partnership and the Investor of the above.

Design philosophy

- Many iterations of the plant layouts were required to utilize agile design, which produced the most efficient process design while maximizing support offices and storage capabilities.

Equipment Selection

- We ensured the selection of international world-class equipment manufacturers with a long-established history of high-quality machinery. Each major piece of equipment is described later in this presentation.

Integrated Controls

- Process Integration has been engaged to design and integrate all of the control systems.

Industrial Internet of Things

Integrated into Warehouse Management, Stock Management, Logistics Management, and Accounting

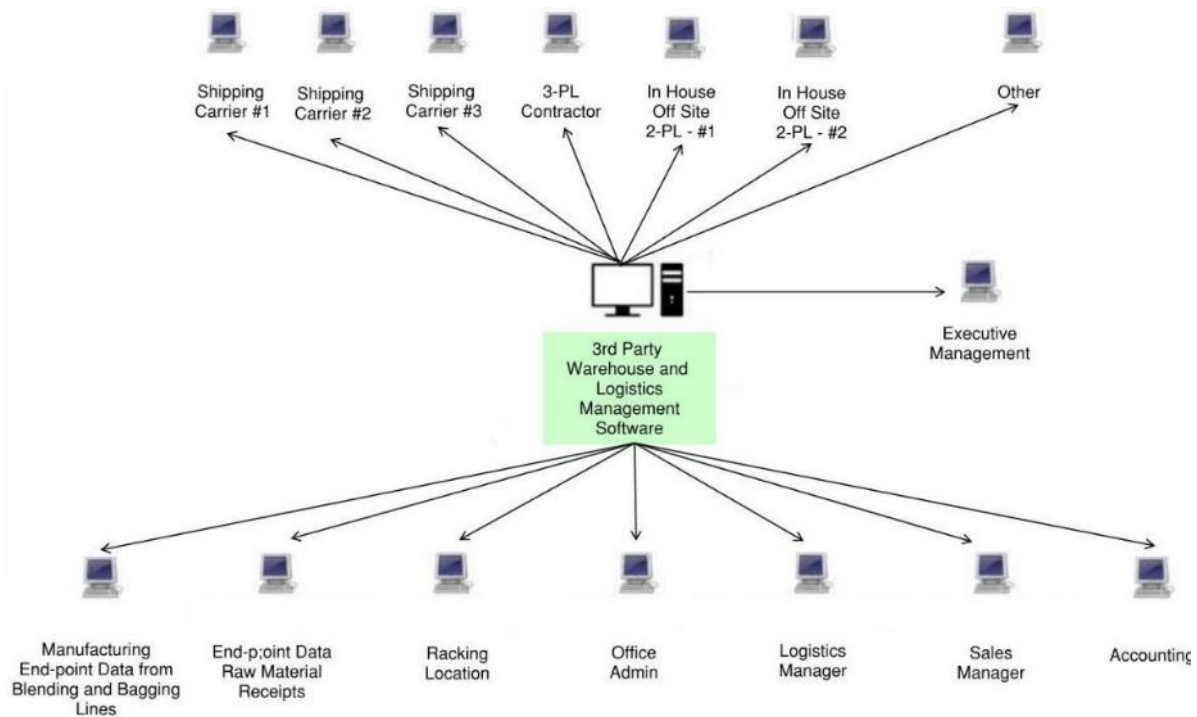

We are exploring integrated software for our Warehouse Management, Stock management, Bar0code management, end-point Date utilization, integrated logistics management, and our enterprise Accounting Systems.

We are considering the following enterprise resource planning (**ERP**) software systems:

Acumatica ERP

Epicor E10 ERP

SAP Business One

TraxView

Shipping

- Our financial Model includes inbound and outbound shipping costs
 - Inbound Shipping of Biosolids
 - Inbound shipping costs of all other fertilizer components
 - Inbound Shipping costs for OT&T goods
 - Outbound Shipping Cost for OT&T finished goods are paid for by the end-user
 - Outbound shipping of finished goods
- Rail is a viable alternative for shipping outside the Midwest
- We need to consult a rail logistics expert

The Bagging Line

- Paper vs. Plastic
- We need the exact specifications of the bag and Label we intend to use
- The bagging line for paper is more expensive
- The bagging line for paper is slower @ 8 → 14 BPM, vs. plastic up to 18-BPM
- Paper tends to get jammed more frequently

Air Quality Control

- We have a system designed by experts in the field
- We have fair pricing for this system
- Mr. John Sudnick has reviewed and is ok with the preliminary design and cost
- Can we sell the dust from the baghouse in bulk bags?

IT – IIOT, Security, and Accounting

- Our IIOT systems integrate Warehouse Management, Logistics Management, Security, Payroll, and Accounting
- Tracking Product and Stock
 - Each bag gets a unique bar code – Date of Production, blend, who was on the line, etc.
 - Product Liability Tracking
 - Each Pallet gets a unique bar code

Project Design, Permitting and Life Safety

Project Integration, LLC

Equipment, Integration, AND Controls,



Process Engineering
Controls and Interface
Structural Design
Major Electrical

OUR COMPANY PROFILE

Project Integration provides ideal, proven project engineering and project management solutions to the industrial marketplace. What sets us apart is smart, dedicated professionals coupled with time-tested strategic technical alliances. Together, we offer our clients:

- Environmental Consulting
- PSM Program Development (Including PHAs)
- Safety Compliance & Training (Including Arc Flash Studies)
- Process Engineering
- Mechanical Engineering
- Electrical and Controls Engineering
- Structural Engineering

In addition to our general services, clients choose Project Integration for many specialty services:

- Air Pollution Control Design
- Combustion Systems Engineering
- Computational Fluid Dynamic (CFD) Modeling
- Piping Design and Stress Analysis
- Stack Design
- Pipe Skid Design
- Arc Flash analysis, safety training, and circuit design

OUR START

The Project Integration story began in 2005. John Sudnick, with more than 25 years of experience, wanted to serve clients in a way that helped them more tangibly. David Kirby had worked with John in the past, and interestingly enough, he saw things about the same way.

Together, John and David did something that most people just could not do. They quit their respective jobs and started Project Integration. Their goal at the time was simple: provide environmental and engineering consulting services, but to do it with a better approach.

From its home in Spartanburg, SC, Project Integration continues to make its mark. The team has grown to 29 professionals serving clients across the US. Project Integration has added many new services to the mix.

OUR CUSTOMERS

Companies across the US choose Project Integration. Our Vision is to have the best reputation in our industry by integrating the customer's input with problem-solving logic to produce meaningful results. Our customers do not just choose Project Integration once. We deliver, and they keep coming back.

So, what companies have trusted us with their engineering and environmental challenges?

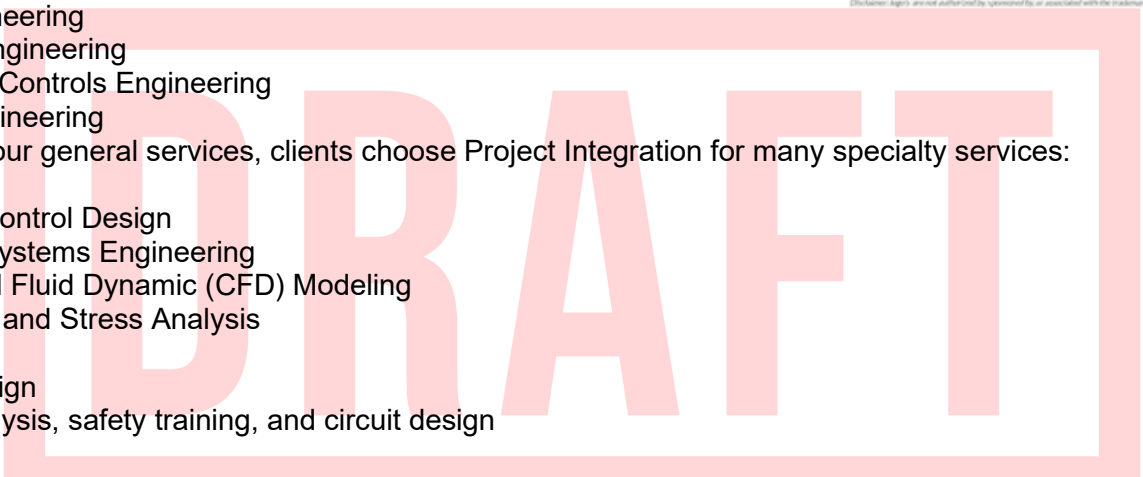



December 18, 2020

Bart R. Lynam
President
Lynam, Inc.
1113 Halladay Drive
Batavia IL 60510

Subject: Proposal for Process Engineering and Process Integration of the Midwest Bagging and Blending Facility.

Reference: Project Integration, Inc. Proposal No. 201109C1

Dear Mr. Lynam,

This document presents Project Integration, Inc.'s (PI's) proposal to provide engineering services for the proposed Midwest Blending and Bagging (BB&G) Facility to be located in Bolingbrook, Illinois. This proposal has been developed in response to your request for proposal dated November 9, 2020 and its attachments.

Background

Lynam Incorporated is leading the effort to construct a fertilizer blending and bagging facility in Bolingbrook, Illinois. The facility will blend biosolids and other fertilizer ingredients, which will be bagged and sold to various agricultural markets.

The BB&G Facility will consist of four main elements:

1. Receiving the fertilizer ingredients by truck
2. Blending the fertilizer ingredients into low moisture, pathogen free, granular pellets
3. Bagging the granular fertilizer pellets, and
4. Warehousing the product in accordance with seasonal demands

The Weaver Consultants Group (Weaver) is working with Lynam Incorporated to provide the architectural services and the mechanical, electrical, and plumbing engineering for the building. Lynam Incorporated has requested a proposal from PI to

1. Generate the technical process information necessary for Weaver to prepare the air permit application and,
2. Provide the engineering and documents for integrating the plant's equipment/controls into Weaver's construction documents.

Project Objectives

PI's proposal has been developed to accomplish the following Lynam Incorporated's objectives:

- Expedite the submission of the air permit application for the facility to minimize permit impacts on the schedule
- Integrate the unit operations of the process to allow for seamless, efficient, and flexible operation.

Scope of Services

As stated above, PI will perform the project in two phases. Phase 1 will perform the following tasks:

Phase 1 Preliminary Process Engineering

Task 1. Meeting with Sackett-Waconia

PI's engineers will meet with Sackett-Waconia engineers to discuss the equipment in their Proposal No. P20-00195 dated August 14, 2020. The purpose of this meeting will be to gather specific information on the proposed system including but not limited to:

- Equipment design
- Equipment physical size and geometry
- Equipment capacity
- Equipment integration and layout
- Equipment limitations
- Equipment control and programming

PI engineers would also obtain equipment general arrangement drawings and cut sheets.

Task 2. Interaction with Nutrients Plus

PI engineers would engage the appropriate personnel at Nutrients Plus to obtain the necessary safety data sheets (SDS) or the necessary information to generate SDS if required.

Task 3. Generation of Deliverables

PI would use the information gathered in Task 1 & 2 to generate the deliverables outlined below. The deliverables would be sent to Lynam Incorporated for review

Mr. Bart R. Lynam
Lynam, Inc.
December 18, 2020

- If the number of drawings, P&IDS, data sheets, or other deliverable exceeds the amount listed in the deliverables section, then PI will provide a change request to cover the additional time and effort.

Phase 2 Preparation of Engineering Package

Task 1 Design of Industrial Ventilation System

PI will design the industrial ventilation system for the facility. This will include duct work, duct work supports, hoods, dampers, fans, and controls and instrumentation. PI will provide purchase specifications for all pieces of equipment.

Task 2 Sizing and Specification of Air Pollution Control Equipment and Odor Control Equipment

PI will size and prepare purchase specifications for all air pollution control and odor control equipment.

Task 3 Design of Controls Integration for All Unit Operations

PI will design the controls integration for all unit operations including:

1. Truck Unloading
2. Bulk Tote Conveyor
3. Material Storage Conveyor
4. Blender Hopper Complex
5. Blender
6. Bagger and Pelleting
7. Ventilation System
8. Air Pollution and Odor Control

Deliverables Phase 2

PI will provide Lynam Incorporated with the following deliverables:

- Ventilation System
 1. Basis for design and sequence of operation
 2. Duct sizing and routing
 3. Hood sizing
 4. Fan sizing
 5. Specifications for:
 - Duct work,

Mr. Bart R. Lynam
Lynam, Inc.
December 18, 2020

Proposed Fee Phase 2

PI proposes to perform the services on a time and materials basis with expected costs between \$50,000 and \$60,000. If additional effort is required, PI will notify Lynam Incorporated that a change order will be required.

Payment Schedule Phase 2

Invoices will be submitted on a bi-weekly basis. Payment shall be required within thirty (30) days of the invoiced date.

Assumptions and Clarifications Phase 2

This Proposal is based on the following assumptions and clarifications:

- Duration of the project shall last no longer than 18 months. If project exceeds 18 months, then PI will provide a change request to cover the additional time and effort.
- If the number of drawings, P&IDS, data sheets, or other deliverable exceeds the amount listed in the deliverables section, then PI will provide a change request to cover the additional time and effort.



A little about Weaver Consultants Group

From its inception in 1991, Weaver Consultants Group has been founded upon the tenets of attentive and responsive customer service, strong project management, and reliable internal financial controls. The quality of our people, our focus on understanding and responding to our clients’ needs, and our application of sound business management practices have resulted in most new projects originating from our existing customer base.

Air Compliance

Weaver Consultants Group specializes in air permitting services for a variety of industries. We assist our clients with federal and state environmental permitting and compliance reporting as well as applicability determinations.

Our energy team understands the foundation for compliance starts with a straightforward air/operating permit that accurately represents the needs of our client’s facilities while providing operating flexibility. We approach each project with a strategy that results in a permit satisfying today’s needs with the flexibility to anticipate future operational demands.

Permitting Services	Compliance Services
Current permit review and evaluations	Annual emission inventories
Permit application preparation and submittal	Emissions fee determinations
Planning and strategy	Emissions trading
Regulatory requirement determinations	Greenhouse gas emissions calculations and reporting
RACT/BACT/MACT/LAER	Monitoring, recordkeeping, and reporting
New Source Performance Standards (NSPS)	Deviation and compliance reporting
National Emission Standards for Hazardous Air Pollutants (NESHAPs)	Compliance reviews and audits
New Source Review (NSR) and Prevention of Significant Deterioration (PSD) permitting	Vapor Combustion/Flare/Vapor Recovery Stack Testing Assistance
Alternative operating scenario development	Opacity Readings
Offset determinations and increment analysis	Regulatory agency liaison and negotiation
Dispersion modeling	Regulation development and tracking (Environmental Policy)
State construction and operating permits	Public meeting representation and presentations
Title V operating permits	Site inspection assistance
Acid rain permitting	Notice of Violation support
Permit modifications (minor and major)	Odor and Noise studies
Compliance Certification Assistance	Compliance Plan Preparation:
Demonstrating and maintaining continuous compliance with the myriad of air quality rules and regulations can be complicated and overwhelming. With our experience, we can guide and assist our clients with all aspects of air compliance.	Start-up, Shutdown, and Malfunction (SSM) Plans and Reporting
	Fugitive Dust Programs
	Housekeeping Plans
	Episode Action Plans
	Preventative Maintenance Plans
	Risk Management Plans (RMP)
	Industries Served



December 7, 2020

Mr. Bart R. Lynam
BioSource Nutrients Illinois, LLC
Midwest Blending and Bagging Facility
Chicago, Illinois

**Re: Proposal for Air Permitting Services
BioSource Nutrients Illinois LLC
Midwest Blending and Bagging
Chicago, Illinois
Proposal No.: WNCP-051-2020-67**

Dear Mr. Lynam:

In response to your request, **Weaver Consultants Group North Central, LLC** (WCG) is pleased to provide you with this Proposal for air permitting services for the above referenced facility (the Facility). The Background, Scope of Work, Schedule, and Cost Estimate to complete our proposed activities are presented in the following sections.

SCOPE OF WORK

BioSource Nutrients Illinois LLC proposes to open a facility that will take biosolids from the Stickney Waste Water Reclamation Plant (Stickney WWRP) and blend it with other ingredients to produce fertilizer. The Facility will be located in Chicago, Illinois. We understand that you are seeking assistance in obtaining a construction permit for the proposed Facility from the Illinois Environmental Protection Agency (IEPA). WCG will work with the Facility to evaluate the potential emissions of regulated air pollutants from the proposed the Facility. Upon determination of the Facility's potential, WCG will evaluate the applicable permitting level with respect to the air permitting requirements in Title 35 of Illinois Administrative Code (35 IAC) Part 201 – *Permits and General Provisions*.

The Chicago-Naperville area has been re-classified from a “moderate” ozone non-attainment area to a “serious” ozone nonattainment area. The result of this non-attainment status change reduces the major source permitting threshold from 100 tons per year (TPY) to 50 TPY for volatile organic material (VOM) and nitrogen oxides (NOx). For purposes of this Proposal, WCG has assumed the potential emission from the Facility will not trigger the non-attainment major New Source Review (NSR) permitting process, which

would require significant amount of air modeling efforts and ecological assessment and the permitting process may take up to 12 months (vs. 90 days for minor construction permitting process).

WCG will assist the Facility to prepare a minor construction permit application with the required supporting documentation. The application package will include the following:

- Cover letter,
- Project description,
- Applicable IEPA application forms,
- Emission calculations and non-major source determination,
- Necessary drawing(s),
- Safety Data Sheets (SDSs), and
- Manufacturer specifications, if available.

A draft application will be provided for your review and comments before final submittal. WCG will assist the Facility with further discussions with IEPA regarding the draft permit review.

If based on our evaluation, it turns out that the proposed Facility will fall in the major source category and therefore trigger non-attainment NSR permitting, this Proposal will need to be modified to account for the additional permitting efforts.

PARTICIPATION BY THE FACILITY

WCG will need the Facility to provide the following information in order to initiate the proposed activities:

- An executed copy of the attached Proposal Acceptance Sheet;
- Block flow process flow diagram for each step of the process from raw material delivery of the dried sludge through bagging;
- Detailed narrative process description of each processing step;
- List of raw materials used in the process (what will be added to the biosolids, show where, and quantities on PFD);
- SDSs for each raw material (including the biosolids);
- Rated processing equipment capacities based on the physical capacity of the equipment;
- Description of emission capture and control methods and equipment;
- Control equipment and manufacturer specifications on outlet concentrations, e.g., if it's a baghouse, please provide the filter efficiency in exit concentration in gr/dscf; and
- Odor control methods and equipment, if available.

WCG may request additional information if needed.

SCHEDULE

WCG is prepared to initiate the activities described in the proposed Scope of Work upon receipt of your authorization to proceed. WCG anticipates having the draft emission calculations described above for your review within 1 – 2 weeks upon receipt of the above listed information. After the potential emission are determined, a draft construction permit application will be provided for your review within 1 – 2 weeks and will be finalized within one week upon receiving your comments and approval.

WCG will communicate any changes to this schedule directly to you throughout the project.

COST ESTIMATE

Based upon our understanding of your objectives, the Scope of Work outlined above can be completed on a time and materials basis for a budget estimate of **\$10,000**. Note, our cost estimate does not include the permit application fee to IEPA. The IEPA permit fee will be further determined based on the permit level and number of emission units/processes.

The estimated cost and proposed Scope of Work are based on information available to WCG at this time. If conditions change, work extends beyond the scheduled completion date, unforeseen circumstances are encountered, or work efforts are redirected, the cost estimate may require modification. We fully expect to complete the proposed Scope of Work for the stated sum, which will not be exceeded without your prior authorization. Any additional consultation or services authorized beyond the Scope of Work presented herein will be billed in accordance with the attached Fee Schedule, unless otherwise agreed.

AUTHORIZATION

Should this Proposal meet with your objectives, please indicate your authorization to proceed by signing and returning the attached Proposal Acceptance Sheet to our office. Execution of the attached Proposal Acceptance Sheet will constitute acceptance of the attached General Terms and Conditions and Fee Schedule, which are incorporated herein by reference. Any modification to this Proposal or the attached General Terms and Conditions and Fee Schedule must be accepted by both parties. This Proposal is valid if accepted within 30 days of issuance and for work performed within 90 days of acceptance.

We appreciate this opportunity to be of service and are looking forward to working with you on this project. If you should have any questions or comments concerning this Proposal, please do not hesitate to contact me at 312-922-1030.

Very Truly Yours,

Weaver Consultants Group North Central, LLC

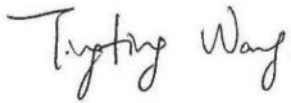

Tingting Wang
Project Manager



Andrew S. Perdue
Project Director

Attachments: Proposal Acceptance Sheet
Fee Schedule
General Terms & Conditions

WEAVER CONSULTANTS GROUP NORTH CENTRAL, LLC
35 East Wacker Drive
Suite 1250
Chicago, Illinois 60601
Voice: 312-922-1030
Fax: 312-922-0201

PROPOSAL ACCEPTANCE SHEET

Description of Services: **Air Permitting Services**
Property Address:
Project City/State: **Chicago, Illinois**
WCG Proposal No.: **WNCP-051-2020-67** Date: **December 7, 2020**
Client Contract No.: Date:

For approval and payment of charges, invoices will be charged to the account of:
Firm: Midwest Blending and Bagging Attention: **Bryant R. Lynam**
Street Address 1: Telephone:
Street Address 2: Fax:
City/State: **Chicago, Illinois**
Zip Code:

This AGREEMENT is subject to the attached General Terms and Conditions Version 2009 – A1 comprising 4 pages and the following special provisions/payment schedule:

Weaver Consultants Group North Central, LLC Proposal Number WNCP-051-2020-67 dated December 7, 2020 and all attachments.

Accepted by: **Weaver Consultants Group North Central, LLC**

Client 

By (Signature) **Andy Perdue**

By (Type/Print) **Project Director**

Title

Accepted _____, 20____
Acknowledge the Terms and Conditions Accepted **December 7, 2020**
Acknowledge the Terms and Conditions

David A. Schaefer Architects PC
Base Building Architectural, Structural MEP, and Life Safety



Architectural Design
Structural
Life Safety
Buildout Electrical
Buildout Plumbing
Buildout Fire Protection
Outbuilding and Foundation Systems



Established in 1997, David A. Schaefer Architects is a full-service, professional architectural design and consulting firm licensed in Illinois, Indiana, Michigan, Wisconsin, Connecticut, and Arizona.

With our robust design, technical and business background, we take a proactive approach and strive to provide creative and timeless design solutions within the construction budget, and which meet and exceed our client's needs.

We are committed to the highest standard of professional service, and we begin each project by actively encouraging participation from the owner during the schematic and design development phases. It is through this collective effort that a successful project and business relationship is built.

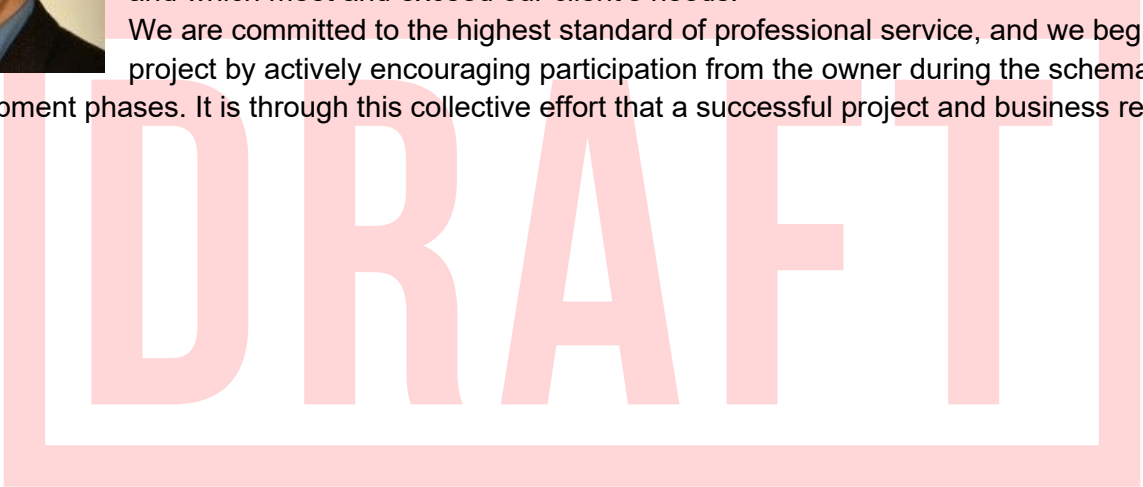

December 18, 2020

Bartholomew R. Lynam
Lynam, Inc.
Batavia, IL 60101



PROPOSAL FOR PROFESSIONAL SERVICES

Thank you very much for the opportunity to provide this proposal to design and produce permit drawings for your new truck off-loading out building and warehouse interior build-out for BioSource Nutrients Illinois LLC in Bolingbrook, IL. The following phases summarize our work scope:

PHASE 1:

Preliminary Design: David A. Schaefer Architects will visit the proposed site and measure and document the affected area in order to produce an as-built document. We will also complete a building and zoning code review and participate in meetings with the owner to fully understand the program requirements. We will develop and present a preliminary floor plan and exterior building elevation options for the owner's review. The preliminary drawings will be revised until all the owner's program requirements are fulfilled (this proposal includes 1 complete revision). Additional Owner directed revisions will be billed at \$185.00/hour.

PHASE 2:

Construction Documents: David A. Schaefer Architects will produce and provide basic signed and sealed construction documents (including Architectural, Civil, Structural, Electrical and Plumbing drawings only) in order to obtain building permits and solicit/negotiate construction trade bids.

PHASE 3:

Permitting: David A. Schaefer Architects will deliver the completed drawings to the Owner/Lynam, Inc so they can submit and apply for the building permit. We will be available to answer and clarify (through written addendum) any questions the city or contractors may have during this phase until the building permit is issued.

Architectural Design and Permit Drawing Fee:	\$27,850.00
Boundary and Topographic Survey Fee:	\$ 3,000.00
Civil Engineering Fee:	\$ 8,500.00
Structural Engineering Fee:	\$ 8,500.00
Electrical and Plumbing Engineering Fee:	\$20,000.00
Total Fixed Fee (Phases 1, 2 and 3 only):	\$67,850.00

- Note 1: We usually require a \$10,000.00 retainer when you are ready for us to proceed with Phase 1.
Note 2: Direct expenses such as; travel, blueprints, postage, etc shall be reimbursed at 1.2x our cost.
Note 3: This fee does not include: City Council, Plan Commission or Board Meetings, Variance or Special Use approvals, Mechanical Engineering, Manual J or S, fire alarm or sprinkler shop drawings, landscape drawings, permit fees, construction administration, cost estimation, 3D renderings or anything else not listed herein.

Bart, I sincerely appreciate your consideration and look forward to working with you again. Thank you and please feel free to call me if you have any questions or require additional information.

Respectfully submitted,
DAVID A. SCHAEFER ARCHITECTS

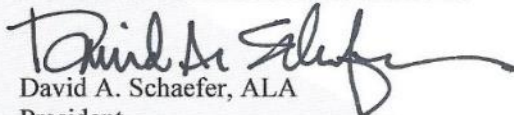
David A. Schaefer, ALA
President

Acceptance:

Bartholomew R. Lynam
Project Manager

DAVID A. SCHAEFER ARCHITECTS PC
2500 S. HIGHLAND AVENUE, SUITE 340
LOMBARD, IL 60148
PHONE 630.261.9250
FAX 630.261.9259
www.das-architects.com

Responsibility Matrix



ILIANA LLC - Chicago Blending and Bagging Facility Responsibility Matrix for Construction Updated 3-15-20

Item Description	Design/Select	Furnished By:	Paid By	Installed By:	Notes
PERMITS, LICENSES and FEES					
Building permits	Architect	Architect	ILIANA LLC	NA	
Illinois EPA Air Permit	Weaver Consulting Group	Weaver Consulting	ILIANA LLC	NA	
Contractor Licenses & Trade Permits	Const. Mngr.	Const. Mngr.	Contractors	NA	
DESIGN & ENGINEERING					
Architectural, Life Safety, and Civil Design	David A. Schaefer Architects	NA	ILIANA LLC	NA	
Mechanical, Buildout Electrical, Buildout Plumbing, Buildout Fire Protection, the Out Building in its entirety including foundation systems & Life Safety	David A. Schaefer Architects	NA	ILIANA LLC	NA	
Structural	David A. Schaefer Architects	NA	ILIANA LLC	NA	
Controls for major equipment, integrating controls	Process Integration	NA	ILIANA LLC	NA	
Design the air quality controls systems	Process Integration	NA	ILIANA LLC	NA	
Electrical Service and Process Electrical	Process Integration	NA	ILIANA LLC	NA	
Review all major Equipment selections	Process Integration	NA	ILIANA LLC	NA	
Review the precast mass-storage bins	Process Integration	NA	ILIANA LLC	NA	
Place and size any concrete pits, angles, grating and other requirements at Sackett's equipment.	Process Integration	NA	ILIANA LLC	NA	
Design and detail any secondary structures required at Sackett's Equipment. - Catwalks and major supports @ support the tripper stub legs	Process Integration	NA	ILIANA LLC	NA	
Design Heat Sensor Alarms at the Mass Storage Bins	Process Integration	NA	ILIANA LLC	NA	
BASE BUILDING MEP					
Electrical Panels	Process Integration	Sub-Contractor	Sub-Contractor	Sub-Contractor	
Light Fixtures	David A. Schaefer Architects	Sub-Contractor	Sub-Contractor	Sub-Contractor	
Plumbing Fixtures	David A. Schaefer Architects	Sub-Contractor	Sub-Contractor	Sub-Contractor	
Heating and Cooling Units	Westside Mechanical, Inc.	Sub-Contractor	Sub-Contractor	Sub-Contractor	
Heating and Cooling ductwork	Westside Mechanical, Inc.	Sub-Contractor	Sub-Contractor	Sub-Contractor	
LOV VOLTAGE SYSTEMS					
IT - Cabling	Const. Mngr.	Elec Contractor	Elec Contractor	Elec Contractor	
Security System and Card Readers	Const. Mngr.	Elec Contractor	Elec Contractor	Elec Contractor	
Fire Alarms	Fire Alar Contractor - Design Build	Elec Contractor	Elec Contractor	Elec Contractor	
EXTERIOR:					
Grounds and Sign - Not in Contract					
INTERIOR FINISHES					
Carpet, LVT, Ceramic and other flooring	David A. Schaefer Architects	Contractor	Contractor	Contractor	
Wall, base, floor and ceiling finishes (not carpet, VWC)	David A. Schaefer Architects	Contractor	Contractor	Contractor	
Paint / Prep at vinyl wall covering	David A. Schaefer Architects	Contractor	Contractor	Contractor	
Doors, frames and hardware	David A. Schaefer Architects	Contractor	Contractor	Contractor	
countertops	David A. Schaefer Architects	Contractor	Contractor	Contractor	
Lunch room upper/lower cabinets & counter tops - Toilet room vanities & Tops	David A. Schaefer Architects	Contractor	Contractor	Contractor	
Toilet room fixtures / trim / accessories	David A. Schaefer Architects	Contractor	Contractor	Contractor	
Architectural Permit Drawings	David A. Schaefer Architects	Contractor	Contractor	Contractor	
Fire Extinguisher and Fire Extinguishers	David A. Schaefer Architects	Contractor	Contractor	Contractor	
BLENDING EQUIPMENT					
Tripper Belt Conveyor	Process Integration	Sackett Waconia	ILIANA LLC	Millwright - Rigger	
Winch	Process Integration	Sackett Waconia	ILIANA LLC	Millwright - Rigger	
Accublend System	Process Integration	Sackett Waconia	ILIANA LLC	Millwright - Rigger	
Micro-Weight hoppers	Process Integration	Sackett Waconia	ILIANA LLC	Millwright - Rigger	
Conveyors	Process Integration	Sackett Waconia	ILIANA LLC	Millwright - Rigger	
Stainless Steel Bulk-Toler Flighted Chain Conveyor	Process Integration	Sackett Waconia	ILIANA LLC	Millwright - Rigger	
Direct Drive Orbital Blender	Process Integration	Sackett Waconia	ILIANA LLC	Millwright - Rigger	
Stainless Steel Centrifugal Belt Type Bucket Elevator	Process Integration	Sackett Waconia	ILIANA LLC	Millwright - Rigger	
Direct Drive Orbital Blender	Process Integration	Sackett Waconia	ILIANA LLC	Millwright - Rigger	
Lot of "Automated" Controls including Computer	Process Integration	Sackett Waconia	ILIANA LLC	Elec Contractor	
Bagging Hopper/ Support Structure	Process Integration				
Catwalks and major supports @ support the tripper	Sackett Waconia	Steel Contractor	Steel Contractor	Steel Contractor	
BAGGING PALLETIZING SHRINKWRAP					
Bagging Equipment	Nutrients-Pluss & Process Integration	Hamer-Fischbein	ILIANA LLC	Millwright - Rigger	
Palletizer	Nutrients-Pluss & Process Integration	Hamer-Fischbein	ILIANA LLC	Millwright - Rigger	
Shrink Wrap Equipment	Nutrients-Pluss & Process Integration	Hamer-Fischbein	ILIANA LLC	Millwright - Rigger	
AIR QUALITY CONTROL					
Odor Scrubber	Westside Mechanical, Inc.	Westside Mechanical,	ILIANA LLC	Mechanical Cont.	
Bag House	Westside Mechanical, Inc.	Westside Mechanical,	ILIANA LLC	Mechanical Cont.	
Air Quality Ductwork System	Westside Mechanical, Inc.	Westside Mechanical,	ILIANA LLC	Mechanical Cont.	
TRUCK SCALE					
Truck Scale	Nutrients-Pluss & Process Integration	Open	ILIANA LLC	Millwright - Rigger	
FURNITURE, FIXTURES, AND EQUIPMENT					
Vehicles, vans, etc.	ILIANA LLC	ILIANA LLC	ILIANA LLC	ILIANA LLC	
Housekeeping equipment - Mops carts, vacuums, etc.	ILIANA LLC	ILIANA LLC	ILIANA LLC	ILIANA LLC	
Kitchen Appliances	ILIANA LLC	ILIANA LLC	ILIANA LLC	ILIANA LLC	
Office furniture, equipment, supplies, chairs, tables, file cabinets, etc.	ILIANA LLC	ILIANA LLC	ILIANA LLC	ILIANA LLC	
Computers, Screens, Router, Cables	ILIANA LLC	ILIANA LLC	ILIANA LLC	ILIANA LLC	
Exterior trash Containers	ILIANA LLC	ILIANA LLC	ILIANA LLC	ILIANA LLC	
Entry mats	ILIANA LLC	ILIANA LLC	ILIANA LLC	ILIANA LLC	
Dumpster (for daily operations)	ILIANA LLC	ILIANA LLC	ILIANA LLC	ILIANA LLC	
Furniture	ILIANA LLC	ILIANA LLC	ILIANA LLC	ILIANA LLC	
Floor and table lamps	ILIANA LLC	ILIANA LLC	ILIANA LLC	ILIANA LLC	
Artwork, artifacts and interior graphics	ILIANA LLC	ILIANA LLC	ILIANA LLC	ILIANA LLC	
Window treatment and hardware	ILIANA LLC	ILIANA LLC	ILIANA LLC	ILIANA LLC	
Projectors and Projection Screens	ILIANA LLC	ILIANA LLC	ILIANA LLC	ILIANA LLC	
Graphics and signage	ILIANA LLC	ILIANA LLC	ILIANA LLC	ILIANA LLC	
ADA Signage	ILIANA LLC	ILIANA LLC	ILIANA LLC	ILIANA LLC	

Communication Matrix

Communication Matrix



ILIANA

BLENDING AND BAGGING LLC

Distribution Code	Document(s)	Issue Codes	Approval Required BY	Controlled Communication	Notes	Distributed to / Communication Type																	
						Investor	Tom Volini	Joe Volini	John Moriarty	Bart T Lynam	Bart R. Lynam	Architect	Process Eng.	3rd Party Expert	Sackett Waconia	David A. Schaefer Architects	Project Integration, Inc.	Weaver Consultants Group	City Agency	Document Control and Archive			
E	Business Management Plan	IFR	TV	TV	Tom Volini - Soul Contact With Investment Team	IC	PLC	T	T	T													
E	Budgets	IFA	TV	TV	Tom Volini - Soul Contact With Investment Team	IC	PC	T	T	T													
	Nutrients Plus																						
E	Procurement Requisitions	IFA	JV				PLC	T															
E	Change Order Requests	IFA	JV				PC	IC	IC														
E	3rd Party Technical and Condition Reports	IFR					PC	PC	IC	IC	IC												
	Proposed Available Properties	IFR	TV		Tom Volini - Soul Contact With Real Estate																		
PLC/E	Conceptual Design Drawings		JM/JV	BRL	Bartholomew Soul Contact with Design		T	T	T	PC	T												
PLC/E	50% Design Development Drawings		JM/JV	BRL	Bartholomew Soul Contact with Design					PC				PLC	PLC	PLC	PLC						IC
PLC/E	50% Design Development Drawings for Permit		JM/JV	BRL	Bartholomew Soul Contact with Design					PC				PLC	PLC	PLC	PLC						IC
PLC/E	Issued for Construction Drawings		JM/JV	BRL	Bartholomew Soul Contact with Design					PC				PLC	PLC	PLC	PLC						IC
E	Weekly Pre-Construction Status Reports			BRL			T	T	T	T	IC												
				BRL																			
E	Weekly Construction Status Reports			BRL			T	T	T	T	IC												
E	Monthly Cost Reports			JV			T	PC	T	T	T												
E	Monthly Schedule Reports			JV			T	PC	T	T	T												

Communications Codes

Distribution Codes		Issue codes	
PC	Push Communication	CD	Conceptual Design Drg's
PLC	Pull Communication	SD	Schematic Design Drg's
IC	Interactive Communication		
T	* = Transmittal only	50%DD	50% Design Development
D	Drop-Box Storage	50%DP	50% DDD for Permit
PS	Paper 11"x17"		
P1	Paper 1 Full Size	IFA	Issued for Approval
P1	Paper 1 Full Size	IFR	Issued for Review and Edit
P1/2	Paper Half size	IFB	Issued For Bids and Pricing
O	Original	IFC	Issued For Construction
CD	CD or DVD	IFF	Issued For Fabrication
E	Electronic	RD	Issued For Record Drawing
		P	Issued For Preliminary
		ASK	Architectural Sketch
		I	Information

Financial Models, Operating Budgets, and the Capital Budget

Financial Considerations and Project Requirements

The Volume of Biosolids Accepted

- Our Modeling Considers the rate of acceptance of Biosolids
- The rate of increase of biosolids accepted per year

Start-Up Capital Requirements:

- Fertilizer components and Biosolids – 3 ½ Months' supply required during Start-Up
- Pallets, bags, and other Sundries
- Training, during Start-Up – Production Staff, Admin Staff, and Sales, Marketing Staff
- Property lease – Costs during construction and start-up

Property Requirements

- Size of Facility
- Ceiling Heights
- Rent / Taxes / CAM
- Office Space Available
- Neighborhood and acceptance of use
- Tax incentives – Opportunity Zones
- Storage Requirements

Seasonal Demands

- Seasonal Cash Flow
- Storage needs
- Seasonal Demand for small equipment - # of forklifts, battery's, and chargers
- Labor Requirement during Peak Months for Shipping

Storage Needs

- Initial needs 20,000 pallets
- Cost of remote storage
- Vendors accepting early deliveries for a discount – Jan -Feb - march

Labor

- Seasonal labor Demands and Available Labor Pool
- Training ahead of peaking labor demands – See below; the same is true for sales

Insurance

- Fertilizer has its own Unique Needs
- State of the art "Air Quality Control " is a big help
- Using 3rd party logistics vs. own truck drivers helps

Marketing and Sales Considerations

- Sales, Marketing and Sales Training, needs to start ahead of ramp-ups
- **Inbound and Outbound Shipping Considerations'**
- **Markets**
 - Model Based On – Midwest
 - Immediate Future -National
 - Future International – Mexico, and Canada

The Financial Model Option-1 May Start, December Production

Option-1 May Start, December Production

	Closing Obligations																					
	May	June	July	August	September	October	November	December	Tot 2021 Yr-1	January	February	Tot 2022 Yr-2	Tot 2023 Yr-3	Tot 2024 Yr-4	Tot 2025 Yr-5	Tot 2026 Yr-6	Tot 2027 Yr-7	Tot 2028 Yr-8	Tot 2029 Yr-9	Tot 2030 Yr-10		
Sales Revenue																						
Biodiesel Tons Utilized - By Who																						
Tonns Available Per Day	4,107 Tons	4,107 Tons	4,107 Tons	4,107 Tons	4,107 Tons	4,107 Tons	4,107 Tons	4,107 Tons	50,000 Tons	4,107 Tons	4,107 Tons	50,000 Tons	50,000 Tons	50,000 Tons	50,000 Tons	50,000 Tons	50,000 Tons	50,000 Tons	50,000 Tons	50,000 Tons	50,000 Tons	
Tonns Available Per Day	139 Tons	139 Tons	139 Tons	139 Tons	139 Tons	139 Tons	139 Tons	139 Tons	139 Tons	139 Tons	139 Tons	139 Tons	139 Tons	139 Tons	139 Tons	139 Tons	139 Tons	139 Tons	139 Tons	139 Tons	139 Tons	
Biodiesel to AGI Turf	4,107 Tons	4,107 Tons	4,107 Tons	4,107 Tons	4,107 Tons	4,107 Tons	4,107 Tons	4,107 Tons	31,428 Tons	4,107 Tons	4,107 Tons	50,000 Tons	50,000 Tons	50,000 Tons	50,000 Tons	50,000 Tons	50,000 Tons	50,000 Tons	50,000 Tons	50,000 Tons	50,000 Tons	
Biodiesel to AGI Turf	0 Tons	0 Tons	0 Tons	0 Tons	0 Tons	0 Tons	0 Tons	0 Tons	3,750 Tons	3,750 Tons	43,000 Tons	43,000 Tons	43,000 Tons	43,000 Tons	43,000 Tons	43,000 Tons	43,000 Tons	43,000 Tons	43,000 Tons	43,000 Tons	43,000 Tons	
Sales	\$0	\$0	\$0	\$0	\$0	\$0	\$0	\$0	\$0	\$0	\$42,948,000	\$60,000,000	\$60,000,000	\$60,000,000	\$60,000,000	\$60,000,000	\$60,000,000	\$60,000,000	\$60,000,000	\$60,000,000	\$60,000,000	
Gross Sales - Scrap	\$900,000	\$900,000	\$900,000	\$900,000	\$900,000	\$900,000	\$900,000	\$900,000	\$2,965,000	\$900,000	\$900,000	\$9,000,000	\$9,000,000	\$9,000,000	\$9,000,000	\$9,000,000	\$9,000,000	\$9,000,000	\$9,000,000	\$9,000,000	\$9,000,000	
Gross Sales - Apx Turf	\$0	\$0	\$0	\$0	\$0	\$0	\$0	\$0	\$0	\$0	\$42,948,000	\$60,000,000	\$60,000,000	\$60,000,000	\$60,000,000	\$60,000,000	\$60,000,000	\$60,000,000	\$60,000,000	\$60,000,000	\$60,000,000	
Less Damaged Goods	\$0	\$0	\$0	\$0	\$0	\$0	\$0	\$0	\$0	\$0	\$0	\$0	\$0	\$0	\$0	\$0	\$0	\$0	\$0	\$0	\$0	
Gross Sales	\$900,000	\$900,000	\$900,000	\$900,000	\$900,000	\$900,000	\$900,000	\$900,000	\$2,965,000	\$900,000	\$900,000	\$9,000,000	\$9,000,000	\$9,000,000	\$9,000,000	\$9,000,000	\$9,000,000	\$9,000,000	\$9,000,000	\$9,000,000	\$9,000,000	
Cost of Goods																						
Beginning Inventory In - Stored Pallets																						
Less Pallets Sold																						
Manufactured Pallets																						
Folding Pallets Stored																						
Inventory - In Dollars (No Labor)																						
Beginning Inventory in Dollars									\$0													
Sold Inventory - Dollars									\$1,126,418													
Manufactured Inventory - Dollars									\$2,252,835													
Ending Inventory - Dollars									\$5,996,042													
Exp - Equipment																						
Building Security, Card Access and CCTV	\$0	\$0	\$0	\$0	\$0	\$0	\$0	\$0	\$700	\$350	\$4,200	\$1,188	\$1,188	\$1,188	\$1,188	\$1,188	\$1,188	\$1,188	\$1,188	\$1,188	\$1,188	
IT/DT Inits, Start, and training	\$0	\$0	\$0	\$0	\$0	\$0	\$0	\$0	\$62,917	\$2,917	\$35,000	\$35,000	\$35,000	\$35,000	\$35,000	\$35,000	\$35,000	\$35,000	\$35,000	\$35,000	\$35,000	
Office Furniture	\$8,000	\$0	\$0	\$0	\$0	\$0	\$0	\$0	\$8,000	\$0	\$0	\$0	\$0	\$0	\$0	\$0	\$0	\$0	\$0	\$0	\$0	
Office Computers, Printers and Cabling	\$12,000	\$0	\$0	\$0	\$0	\$0	\$0	\$0	\$12,000	\$0	\$0	\$0	\$0	\$0	\$0	\$0	\$0	\$0	\$0	\$0	\$0	
Office Equipment	\$2,500	\$0	\$0	\$0	\$0	\$0	\$0	\$0	\$2,500	\$0	\$0	\$0	\$0	\$0	\$0	\$0	\$0	\$0	\$0	\$0	\$0	
Equipment maintenance and spare Parts	\$0	\$0	\$0	\$0	\$0	\$0	\$0	\$0	\$0	\$750	\$9,000	\$18,000	\$36,000	\$36,000	\$36,000	\$36,000	\$36,000	\$36,000	\$36,000	\$36,000	\$36,000	
Elect Equipment	\$0	\$0	\$0	\$0	\$0	\$0	\$0	\$0	\$1,000	\$0	\$0	\$2,000	\$2,000	\$2,000	\$2,000	\$2,000	\$2,000	\$2,000	\$2,000	\$2,000	\$2,000	
Electric Pallet Jack	\$0	\$0	\$0	\$0	\$0	\$0	\$0	\$0	\$0	\$0	\$600	\$1,188	\$1,188	\$1,188	\$1,188	\$1,188	\$1,188	\$1,188	\$1,188	\$1,188	\$1,188	
Forklifts - Lease	\$0	\$0	\$0	\$0	\$0	\$0	\$0	\$0	\$1,520	\$54,720	\$74,400	\$74,400	\$74,400	\$74,400	\$74,400	\$74,400	\$74,400	\$74,400	\$74,400	\$74,400	\$74,400	
Propane Storage System	\$0	\$0	\$0	\$0	\$0	\$0	\$0	\$0	\$8,183	\$14,028	\$14,028	\$14,028	\$14,028	\$14,028	\$14,028	\$14,028	\$14,028	\$14,028	\$14,028	\$14,028	\$14,028	
Pallet Jack System	\$0	\$0	\$0	\$0	\$0	\$0	\$0	\$0	\$300	\$0	\$0	\$600	\$600	\$600	\$600	\$600	\$600	\$600	\$600	\$600	\$600	
Company Vehicle	\$0	\$0	\$0	\$0	\$0	\$0	\$0	\$0	\$152,869	\$261,204	\$261,204	\$261,204	\$261,204	\$261,204	\$261,204	\$261,204	\$261,204	\$261,204	\$261,204	\$261,204	\$261,204	
Other Expense	\$22,000	\$0	\$0	\$0	\$22,000	\$2,600	\$2,600	\$31,200	\$43,088	\$43,187	\$295,715	\$433,088	\$433,088	\$433,088	\$433,088	\$433,088	\$433,088	\$433,088	\$433,088	\$433,088	\$433,088	
Production Expenses																						
Raw Materials for Manufactured Inventory	\$0	\$0	\$0	\$0	\$0	\$0	\$0	\$1,126,418	\$1,126,418	\$1,400,000	\$25,328,350	\$30,037,800	\$30,037,800	\$30,037,800	\$30,037,800	\$30,037,800	\$30,037,800	\$30,037,800	\$30,037,800	\$30,037,800	\$30,037,800	
OT/ET of Goods to Viola	\$91,667	\$91,667	\$91,667	\$91,667	\$91,667	\$91,667	\$91,667	\$50,417	\$682,083	\$9,167	\$9,167	\$110,000	\$0	\$0	\$0	\$0	\$0	\$0	\$0	\$0	\$0	
OT/ET Operating Costs (Base Cost)	\$93,000	\$93,000	\$93,000	\$93,000	\$93,000	\$93,000	\$93,000	\$93,000	\$90,100	\$9,300	\$9,300	\$111,000	\$0	\$0	\$0	\$0	\$0	\$0	\$0	\$0	\$0	
Propane - Axi Stoves	\$0	\$0	\$0	\$0	\$0	\$0	\$0	\$1,200	\$2,400	\$1,200	\$1,200	\$1,400	\$1,400	\$1,400	\$1,400	\$1,400	\$1,400	\$1,400	\$1,400	\$1,400	\$1,400	
Waters Transfer - Axi Stoves Burn	\$0	\$0	\$0	\$0	\$0	\$0	\$0	\$46,800	\$93,600	\$117,800	\$117,800	\$117,800	\$117,800	\$117,800	\$117,800	\$117,800	\$117,800	\$117,800	\$117,800	\$117,800	\$117,800	
Waters Transfer - Axi Stoves Burn	\$0	\$0	\$0	\$0	\$0	\$0	\$0	\$0	\$0	\$0	\$0	\$0	\$0	\$0	\$0	\$0	\$0	\$0	\$0	\$0	\$0	
Outbound Lot Shift - Forklift	\$184,467	\$184,467	\$184,467	\$184,467	\$184,467	\$184,467	\$184,467	\$184,467	\$184,467	\$1,543,921	\$27,261,627	\$33,874,897	\$33,874,897	\$33,874,897	\$33,874,897	\$33,874,897	\$33,874,897	\$33,874,897	\$33,874,897	\$33,874,897	\$33,874,897	
Production and Opa Expenses	\$207,167	\$184,467	\$184,467	\$184,467	\$184,467	\$184,467	\$184,467	\$184,467	\$210,217	\$1,543,921	\$27,261,627	\$33,874,897	\$33,874,897	\$33,874,897	\$33,874,897	\$33,874,897	\$33,874,897	\$33,874,897	\$33,874,897	\$33,874,897	\$33,874,897	
Facility Rent and Utilities																						
Rent - Land Lease	\$43,917	\$43,917	\$43,917	\$43,917	\$43,917	\$43,917	\$43,917	\$43,917	\$43,917	\$1,550,110	\$7,750,555	\$12,850,925	\$12,850,925	\$12,850,925	\$12,850,925	\$12,850,925	\$12,850,925	\$12,850,925	\$12,850,925	\$12,850,925	\$12,850,925	
Electricity Costs	\$0	\$0	\$0	\$0	\$0	\$0	\$0	\$0	\$44,795	\$44,795	\$537,640	\$537,640	\$537,640	\$537,640	\$537,640	\$537,640	\$537,640	\$537,640	\$537,640	\$537,640	\$537,640	
Telephone	\$0	\$0	\$0	\$0	\$0	\$0	\$0	\$0	\$4,000	\$4,000	\$48,000	\$48,000	\$48,000	\$48,000	\$48,000	\$48,000	\$48,000	\$48,000	\$48,000	\$48,000	\$48,000	
Garbage Pickup	\$0	\$0	\$0	\$0	\$0	\$0	\$0	\$0	\$450	\$450	\$5,400	\$5,400	\$5,400	\$5,400	\$5,400	\$5,400	\$5,400	\$5,400	\$5,400	\$5,400	\$5,400	
Winter Costs	\$0	\$0	\$0	\$0	\$0	\$0	\$0	\$0	\$130	\$130	\$1,560	\$1,560	\$1,560	\$1,560	\$1,560	\$1,560	\$1,560	\$1,560	\$1,560	\$1,560	\$1,560	
Natural Gas	\$0	\$0	\$0	\$0	\$0	\$0	\$0	\$0	\$800	\$800	\$9,600	\$9,600	\$9,600	\$9,600	\$9,600	\$9,600	\$9,600	\$9,600	\$9,600	\$9,600	\$9,600	
Facility Rent and Utilities	\$43,917	\$43,917	\$43,917	\$43,917	\$43,917	\$43,917	\$43,917	\$43,917	\$48,762	\$49,000	\$62,800	\$62,800	\$62,800	\$62,800	\$62,800	\$62,800	\$62,800	\$62,800	\$62,800	\$62,800	\$62,800	
Inbound and Outbound Transportation Expense																						
Inbound Shipping - Bioisdies - Stocking to	\$0	\$0	\$0	\$0	\$0	\$0	\$0	\$0	\$11,250	\$22,500	\$270,000	\$438,626	\$438,626	\$438,626	\$438,626	\$438,626	\$438,626	\$438,626	\$438,626	\$438,626	\$438,626	
Outbound Shipping - Sales Endpoint	\$0	\$0	\$0	\$0	\$0	\$0	\$0	\$0	\$149,671	\$1,870,851	\$1,138,490	\$0	\$0	\$0	\$0	\$0	\$0	\$0	\$0	\$0	\$0	
Ag Turf Inbound Shipping Costs	\$56,833	\$56,833	\$56,833	\$56,833	\$56,833	\$56,833	\$56,833	\$56,833	\$56,833	\$5,683	\$68,000	\$0	\$0	\$0	\$0	\$0	\$0	\$0	\$0	\$0	\$0	
Inbound and Outbound Transportation Expense	\$56,833	\$56,833	\$56,833	\$56,833	\$56,833	\$56,833	\$56,833	\$56,833	\$442,992	\$4,643	\$4,270,251	\$1,637,116	\$1,637,116	\$1,637,116	\$1,637,116	\$1,637,116	\$1,637,116	\$1,637,116	\$1,637,116	\$1,637,116	\$1,637,116	
Selling +71.97 Expenses																						
Sales Person - 1 Senior	\$0	\$0	\$0	\$0	\$0	\$0	\$0	\$0	\$48,742	\$24,371	\$288,504	\$288,504	\$288,504	\$288,504	\$288,504	\$288,504	\$288,504	\$288,504	\$288,504	\$288,504	\$288,504	
Sales Person - 1 Junior	\$0	\$0	\$0	\$0	\$0	\$0	\$0	\$0	\$24,371	\$12,185	\$148,752	\$148,752	\$148,752	\$148,752	\$148,752	\$148,752	\$148,752	\$148,752	\$148,752	\$148,752	\$148,752	
Travel and Per Diem	\$0	\$0	\$0	\$0	\$0	\$0	\$0	\$0	\$0	\$0	\$0	\$0	\$0	\$0	\$0	\$0	\$0	\$0	\$0	\$0	\$0	
Advertising	\$0	\$0	\$0	\$0	\$0	\$0	\$0	\$0	\$0	\$0	\$0	\$0	\$0	\$0	\$0	\$0	\$0	\$0	\$0	\$0	\$0	
Selling Expenses	\$0	\$0	\$0	\$0	\$0	\$0	\$0	\$0	\$73,113	\$24,356	\$437,256	\$437,256	\$437,256	\$437,256	\$437,256	\$437,256	\$437,256	\$437,256	\$437,256	\$437,256	\$437,256	
General and Admin Expense																						
Regional Manager/ Sales Manager	\$0	\$0	\$0	\$0	\$0	\$0	\$0	\$0	\$21,411	\$21,411	\$256,928	\$25										

Option-2 August Start, June Production

ILIANA Blending and Bagging

April 15th, 2023

Option-2 August Start, June Production

		Closing Obligations																			
		May	June	July	August	September	October	November	December	Tot 2021 Yr-1	January	Tot 2022 Yr-2	Tot 2023 Yr-3	Tot 2024 Yr-4	Tot 2025 Yr-5	Tot 2026 Yr-6	Tot 2027 Yr-7	Tot 2028 Yr-8	Tot 2029 Yr-9	Tot 2030 Yr-10	
Sales Revenue																					
Biosolids Tons Utilized - By Who																					
Biosolids Available Per Year		0 - Tons	0 - Tons	0 - Tons	4,167 - Tons	4,167 - Tons	4,167 - Tons	4,167 - Tons	4,167 - Tons	50,000 - Tons	4,167 - Tons	50,000 - Tons	50,000 - Tons	50,000 - Tons	50,000 - Tons	50,000 - Tons	50,000 - Tons	50,000 - Tons	50,000 - Tons	50,000 - Tons	
Biosolids Available Per Day		0 - Tons	0 - Tons	0 - Tons	139 - Tons	139 - Tons	139 - Tons	139 - Tons	139 - Tons	139 - Tons	139 - Tons	139 - Tons	139 - Tons	139 - Tons	139 - Tons	139 - Tons	139 - Tons	139 - Tons	139 - Tons	139 - Tons	
Biosolids to Ag-Turf		0 - Tons	0 - Tons	0 - Tons	4,167 - Tons	4,167 - Tons	4,167 - Tons	4,167 - Tons	4,167 - Tons	20,833 - Tons	4,167 - Tons	50,000 - Tons	50,000 - Tons	50,000 - Tons	50,000 - Tons	50,000 - Tons	50,000 - Tons	50,000 - Tons	50,000 - Tons	50,000 - Tons	
Biosolids to Screaming Green		0 - Tons	0 - Tons	0 - Tons	0 - Tons	0 - Tons	0 - Tons	0 - Tons	0 - Tons	0 - Tons	0 - Tons	45,000 - Tons	50,000 - Tons	50,000 - Tons	50,000 - Tons	50,000 - Tons	50,000 - Tons	50,000 - Tons	50,000 - Tons	50,000 - Tons	
Sales - Dollars		\$0	\$0	\$0	\$0	\$0	\$0	\$0	\$0	\$0	\$25,660,000	\$30,000,000	\$60,000,000	\$60,000,000	\$60,000,000	\$60,000,000	\$60,000,000	\$60,000,000	\$60,000,000	\$60,000,000	
Gross Sales - Ag-Turf		\$0	\$0	\$0	\$300,000	\$300,000	\$300,000	\$300,000	\$300,000	\$1,900,000	\$1,224,000	\$0	\$0	\$0	\$0	\$0	\$0	\$0	\$0	\$0	
Gross Sales - Ag-Turf		\$0	\$0	\$0	\$300,000	\$300,000	\$300,000	\$300,000	\$300,000	\$1,900,000	\$1,224,000	\$0	\$0	\$0	\$0	\$0	\$0	\$0	\$0	\$0	
Gross Sales - Ag-Turf		\$0	\$0	\$0	\$300,000	\$300,000	\$300,000	\$300,000	\$300,000	\$1,900,000	\$1,224,000	\$0	\$0	\$0	\$0	\$0	\$0	\$0	\$0	\$0	
Less Damaged Goods		\$0	\$0	\$0	\$0	\$0	\$0	\$0	\$0	\$0	\$0	\$0	\$0	\$0	\$0	\$0	\$0	\$0	\$0	\$0	
GROSS SALES		\$0	\$0	\$0	\$300,000	\$300,000	\$300,000	\$300,000	\$300,000	\$1,900,000	\$1,224,000	\$0	\$0	\$0	\$0	\$0	\$0	\$0	\$0	\$0	
Cost of Goods																					
Inventory - In # of PALLETS		0 Pallets	0 Pallets	0 Pallets	0 Pallets	0 Pallets	0 Pallets	0 Pallets	0 Pallets	0 Pallets	0 Pallets	0 Pallets	0 Pallets	0 Pallets	0 Pallets	0 Pallets	0 Pallets	0 Pallets	0 Pallets	0 Pallets	
Beginning Inventory in Stored Pallets		0 Pallets	0 Pallets	0 Pallets	0 Pallets	0 Pallets	0 Pallets	0 Pallets	0 Pallets	0 Pallets	0 Pallets	0 Pallets	0 Pallets	0 Pallets	0 Pallets	0 Pallets	0 Pallets	0 Pallets	0 Pallets	0 Pallets	
Less Pallets Sold		0 Pallets	0 Pallets	0 Pallets	0 Pallets	0 Pallets	0 Pallets	0 Pallets	0 Pallets	0 Pallets	0 Pallets	0 Pallets	0 Pallets	0 Pallets	0 Pallets	0 Pallets	0 Pallets	0 Pallets	0 Pallets	0 Pallets	
Ending Pallets Stored		0 Pallets	0 Pallets	0 Pallets	0 Pallets	0 Pallets	0 Pallets	0 Pallets	0 Pallets	0 Pallets	0 Pallets	0 Pallets	0 Pallets	0 Pallets	0 Pallets	0 Pallets	0 Pallets	0 Pallets	0 Pallets	0 Pallets	
Inventory - In Dollars (No Labor)		\$0	\$0	\$0	\$0	\$0	\$0	\$0	\$0	\$0	\$0	\$0	\$0	\$0	\$0	\$0	\$0	\$0	\$0	\$0	
Beginning Inventory in Dollars		\$0	\$0	\$0	\$0	\$0	\$0	\$0	\$0	\$0	\$0	\$0	\$0	\$0	\$0	\$0	\$0	\$0	\$0	\$0	
Sold Inventory - Dollars		\$0	\$0	\$0	\$0	\$0	\$0	\$0	\$0	\$0	\$0	\$0	\$0	\$0	\$0	\$0	\$0	\$0	\$0	\$0	
Manufactured Inventory - Dollars		\$0	\$0	\$0	\$0	\$0	\$0	\$0	\$0	\$0	\$0	\$0	\$0	\$0	\$0	\$0	\$0	\$0	\$0	\$0	
Ending Inventory - Dollars		\$0	\$0	\$0	\$0	\$0	\$0	\$0	\$0	\$0	\$0	\$0	\$0	\$0	\$0	\$0	\$0	\$0	\$0	\$0	
OpEx - Equipment																					
Building Security, Card Access and CCTV		\$0	\$0	\$0	\$0	\$0	\$0	\$0	\$0	\$0	\$0	\$0	\$0	\$0	\$0	\$0	\$0	\$0	\$0	\$0	
IITOT Install, Start, and training		\$0	\$0	\$0	\$0	\$0	\$0	\$0	\$0	\$0	\$0	\$0	\$0	\$0	\$0	\$0	\$0	\$0	\$0	\$0	
Electric Pallet Jack		\$0	\$0	\$0	\$0	\$0	\$0	\$0	\$0	\$0	\$0	\$0	\$0	\$0	\$0	\$0	\$0	\$0	\$0	\$0	
Office Furniture		\$0	\$0	\$0	\$0	\$0	\$0	\$0	\$0	\$0	\$0	\$0	\$0	\$0	\$0	\$0	\$0	\$0	\$0	\$0	
Office Computers, Printers and Cabling		\$0	\$0	\$0	\$0	\$0	\$0	\$0	\$0	\$0	\$0	\$0	\$0	\$0	\$0	\$0	\$0	\$0	\$0	\$0	
Office Equipment		\$0	\$0	\$0	\$0	\$0	\$0	\$0	\$0	\$0	\$0	\$0	\$0	\$0	\$0	\$0	\$0	\$0	\$0	\$0	
Equipment maintenance and spare Parts		\$0	\$0	\$0	\$0	\$0	\$0	\$0	\$0	\$0	\$0	\$0	\$0	\$0	\$0	\$0	\$0	\$0	\$0	\$0	
Shop Equipment		\$0	\$0	\$0	\$0	\$0	\$0	\$0	\$0	\$0	\$0	\$0	\$0	\$0	\$0	\$0	\$0	\$0	\$0	\$0	
Electric Pallet Jack		\$0	\$0	\$0	\$0	\$0	\$0	\$0	\$0	\$0	\$0	\$0	\$0	\$0	\$0	\$0	\$0	\$0	\$0	\$0	
Forklifts - Lease		\$0	\$0	\$0	\$0	\$0	\$0	\$0	\$0	\$0	\$0	\$0	\$0	\$0	\$0	\$0	\$0	\$0	\$0	\$0	
Skid Steer		\$0	\$0	\$0	\$0	\$0	\$0	\$0	\$0	\$0	\$0	\$0	\$0	\$0	\$0	\$0	\$0	\$0	\$0	\$0	
Propane Storage System		\$0	\$0	\$0	\$0	\$0	\$0	\$0	\$0	\$0	\$0	\$0	\$0	\$0	\$0	\$0	\$0	\$0	\$0	\$0	
Pallet Rack System		\$0	\$0	\$0	\$0	\$0	\$0	\$0	\$0	\$0	\$0	\$0	\$0	\$0	\$0	\$0	\$0	\$0	\$0	\$0	
Company Vehicle		\$0	\$0	\$0	\$0	\$0	\$0	\$0	\$0	\$0	\$0	\$0	\$0	\$0	\$0	\$0	\$0	\$0	\$0	\$0	
OpEx Expense		\$0	\$0	\$0	\$44,500	\$2,600	\$2,600	\$2,600	\$2,600	\$120,017	\$6,817	\$274,435	\$433,088	\$437,788	\$446,788	\$450,088	\$457,711	\$461,109	\$465,711	\$470,411	
Production Expenses																					
Raw Materials for Manufactured Inventory		\$0	\$0	\$0	\$0	\$0	\$0	\$0	\$0	\$0	\$0	\$0	\$0	\$0	\$0	\$0	\$0	\$0	\$0	\$0	
OT&S Cost of Goods To Vendor		\$0	\$0	\$0	\$0	\$0	\$0	\$0	\$0	\$0	\$0	\$0	\$0	\$0	\$0	\$0	\$0	\$0	\$0	\$0	
OT&S Operating Costs (Base Case)		\$0	\$0	\$0	\$0	\$0	\$0	\$0	\$0	\$0	\$0	\$0	\$0	\$0	\$0	\$0	\$0	\$0	\$0	\$0	
Programs - Solid Steers		\$0	\$0	\$0	\$0	\$0	\$0	\$0	\$0	\$0	\$0	\$0	\$0	\$0	\$0	\$0	\$0	\$0	\$0	\$0	
Gross Weight Production Shift		\$0	\$0	\$0	\$0	\$0	\$0	\$0	\$0	\$0	\$0	\$0	\$0	\$0	\$0	\$0	\$0	\$0	\$0	\$0	
Wages Loading Outbound 1st Shift - Forklift		\$0	\$0	\$0	\$0	\$0	\$0	\$0	\$0	\$0	\$0	\$0	\$0	\$0	\$0	\$0	\$0	\$0	\$0	\$0	
Production Expense		\$0	\$0	\$0	\$184,667	\$184,667	\$184,667	\$184,667	\$184,667	\$322,546	\$322,546	\$322,546	\$322,546	\$322,546	\$322,546	\$322,546	\$322,546	\$322,546	\$322,546	\$322,546	
Production and OpEx Expenses		\$0	\$0	\$0	\$229,167	\$187,267	\$187,267	\$187,267	\$187,267	\$322,546	\$322,546	\$322,546	\$322,546	\$322,546	\$322,546	\$322,546	\$322,546	\$322,546	\$322,546	\$322,546	
Facility Rent and Utilities																					
Rent - Land Lease		\$0	\$0	\$0	\$43,917	\$43,917	\$43,917	\$43,917	\$43,917	\$219,585	\$44,735	\$37,544	\$548,295	\$559,261	\$570,446	\$570,446	\$570,446	\$570,446	\$570,446	\$570,446	
Electricity Costs		\$0	\$0	\$0	\$2,500	\$2,500	\$2,500	\$2,500	\$2,500	\$10,100	\$4,000	\$48,000	\$48,939	\$49,939	\$49,938	\$49,938	\$49,938	\$49,938	\$49,938	\$49,938	
Gas		\$0	\$0	\$0	\$0	\$0	\$0	\$0	\$0	\$0	\$0	\$0	\$0	\$0	\$0	\$0	\$0	\$0	\$0	\$0	
Garage Pickup		\$0	\$0	\$0	\$423	\$423	\$423	\$423	\$423	\$1,800	\$700	\$2,800	\$2,800	\$2,800	\$2,800	\$2,800	\$2,800	\$2,800	\$2,800	\$2,800	
Water Costs		\$0	\$0	\$0	\$0	\$0	\$0	\$0	\$0	\$0	\$0	\$0	\$0	\$0	\$0	\$0	\$0	\$0	\$0	\$0	
Natural Gas		\$0	\$0	\$0	\$0	\$0	\$0	\$0	\$0	\$0	\$0	\$0	\$0	\$0	\$0	\$0	\$0	\$0	\$0	\$0	
Facility Rent and Utilities		\$0	\$0	\$0	\$43,917	\$46,932	\$46,932	\$46,932	\$46,932	\$237,915	\$52,220	\$62,644	\$638,385	\$650,361	\$662,576	\$662,576	\$662,576	\$662,576	\$662,576	\$662,576	
Inbound Shipping - Biosolids - Stockpile to		\$0	\$0	\$0	\$0	\$0	\$0	\$0	\$0	\$0	\$0	\$0	\$0	\$0	\$0	\$0	\$0	\$0	\$0	\$0	
Outbound Shipping - Sales Endpoint		\$0	\$0	\$0	\$0	\$0	\$0	\$0	\$0	\$0	\$0	\$0	\$0	\$0	\$0	\$0	\$0	\$0	\$0	\$0	
Ag-Turf Inbound Shipping Costs		\$0	\$0	\$0	\$56,833	\$56,833	\$56,833	\$56,833	\$56,833	\$284,167	\$56,833	\$231,800	\$1,138,960	\$1,138,960	\$1,138,960	\$1,138,960	\$1,138,960	\$1,138,960	\$1,138,960	\$1,138,960	
Inbound and Outbound Transportation Exp		\$0	\$0	\$0	\$56,833	\$56,833	\$56,833	\$56,833	\$56,833	\$284,167	\$56,833	\$231,800	\$1,138,960	\$1,138,960	\$1,138,960	\$1,138,960	\$1,138,960	\$1,138,960	\$1,138,960	\$1,138,960	
Selling - *1127 Expenses		\$0	\$0	\$0	\$0	\$0	\$0	\$0	\$0	\$0	\$0	\$0	\$0	\$0	\$0	\$0	\$0	\$0	\$0	\$0	
Sales Persons - 1 Senior		\$0	\$0	\$0	\$0	\$0	\$0	\$0	\$0	\$0	\$0	\$0	\$0	\$0	\$0	\$0	\$0	\$0	\$0	\$0	
Travel and Per Diem		\$0	\$0	\$0	\$0	\$0	\$0	\$0	\$0	\$0	\$0	\$0	\$0	\$0	\$0	\$0	\$0	\$0	\$0	\$0	
Sales Persons - 2		\$0	\$0	\$0	\$0	\$0	\$0	\$0	\$0	\$0	\$0	\$0	\$0	\$0	\$0	\$0	\$0	\$0	\$0	\$0	
Travel and Per Diem		\$0	\$0	\$0	\$0	\$0	\$0	\$0	\$0	\$0	\$0	\$0	\$0	\$0	\$0	\$0	\$0	\$0	\$0	\$0	
Advertising		\$0	\$0																		

Financial Model Assumptions

Midwest Blending and Bagging Final Assumptions

Cost of Goods Assumptions

Clarius Components	Cost Per Ton Raw Goods	% Required in Blend	% Required in Blend No Labor	Cost Per Ton Finished Goods
Urea	\$362.00 per Ton	9.0%	10.846%	\$32.58 per Ton
Amm Sulfate	\$295.00 per Ton	11.0%	10.803%	\$32.45 per Ton
SCU	\$632.00 per Ton	16.8%	35.347%	\$106.18 per Ton
SOP	\$775.00 per Ton	6.0%	15.480%	\$46.50 per Ton
Poultry Compost	\$320.00 per Ton	8.0%	8.523%	\$25.60 per Ton
Biosolid	\$54.00 per Ton	49.3%	8.863%	\$26.62 per Ton
Bag	\$20.00 per Ton	1 Required	6.658%	\$20.00 per Ton
Label	\$3.20 per Ton	1 Required	1.065%	\$3.20 per Ton
Pallet	\$7.25 per Ton	1 Required	2.414%	\$7.25 per Ton
Subtotal			100%	\$300.38 per Ton
Labor	\$5.00 per Ton	5 Required		\$25.00 per Ton
Total Cost of Clarus Product and Components				\$325.38 per Ton

Selling, General and Administrative Expense (SG&A)

Description	Non-Union Wage 2021	Required Per Shift		
Non-Union Forklift Driver	\$8,566 Per Month			
Non-Union Skid Steer Driver	\$7,712 Per Month			
Non-Union Truck Driver 5-axil Class-3	\$11,350 Per Month			
Warehouse / Control Room Manager	\$11,008 Per Month			
Regional Manager / Sales Manager	\$26,868 Per Month			
Office / Logistics Manager - Exec Level	\$10,054 Per Month			
Administrative Assistant	\$6,537 Per Month			
Description	Value	% Applied		Annual Cost
Equipment Maintenance and Repairs	\$3,603,141	0.75%		\$27,024 Per Year
IIoT - Prod'n, Stock, Logistics Software			Starting mid 2022 Costs	\$15,600 Per Year
Accounting Software			Starting 2021 Costs	\$10,800 Per Year
ADT - Payroll Service				\$17.75 per Employee Transaction

Biosolids Details

Description	Per Day Actual	Per Year 12-27-20	
Biosolids Available @ 100/Tons Per Day		36,500.00 Tons per Year	
Biosolids Available @ 150/Tons Per Day		54,750.00 Tons per Year	
Maximum Biosolids Available @ 230/Tons Per Day		83,950.00 Tons per Year	
2021 Biosolids to OT&T		35,875.00 Tons per Year	
Veolia 10-yr Obligated Tons to OT&T		30,000.00 Tons per Year	
July MBM Dry Tons per Day	100.00 Tons/Day		
August MBM Dry Tons per Day	205.00 Tons/Day		
September MBM Dry Tons per Day	128.00 Tons/Day		
October MBM Dry Tons per Day	137.00 Tons/Day		
Current Average July - October	142.50 Tons/Day	52,012.50 Tons per Year	
Veolia Production used in Por Forma	130.00 Tons/Day	47,450.00 Tons per Year	

Insurance Based on 2025 Sales and Inventory and Prorated every Year

Construction Insurance			
Builders Risk	\$6,500	Lump Sum	
Inland Marine for new equip	\$5,500	Lump Sum	
Operating Business Insurance			
General Property and Stored Stock insurance	\$3,750.00	0.25%	Per Annual of the Average stored stock for the year - Assume Ave Stock on hand = \$1,500,000
Equipment insurance	\$11,825.68	0.25%	Per Annual of total Equipment Costs
Public Product liability		0.215%	Per Annual of total Sold Goods
General liability \$3mm with a \$5mm umbrella	\$18,000	Per Annual	
Workman's Compensation Insurance - Production	\$9,764.50		12.5% Of 74% Total Payroll - No Burdens
Workman's Compensation Insurance - Office	\$11,264.40		3.0% Of 72% Total Payroll - No Burdens
Landlord Renters insurance	\$3,500		
Inland Marine Shipped Goods		0.055%	Of Cost of Goods Transported
Auto Insurance	\$2,200		
Total Insurance Full Operating Capacity - Year 2025	\$60,304.58		

Midwest Blending and Bagging
Final Assumptions

Property Assumptions			
Description		Annual Lease Rate Model-1	Annual Lease Rate Model-2 or Cost
Target Square Footage Model-1	171,638.00 Square Feet		
Target Square Footage Model-2	264,638.00 Square Feet		
Target Net Lease Rate	3.75 Per Square Foot		
Target Real Estate Taxes	1.20 Per Square Foot		
Target Common Area Expenses	0.70 Per Square Foot		
Thus Triple Net Lease Rate	5.65 Per Square Foot	\$969,754.70	\$1,495,204.70
Model_1_Annual_Lease_Rate	\$969,755		
Target Monthly Triple Net Lease Rate	\$80,813		
Target Ceiling Height Required	30.00 Foot		
Power Required	1,200.00 Amps		
Voltage Required	480/208 Volts		
Available Power			
Available Office Square Footage			
Assumed Cost Office Alt's and Buildout Production Locker/Lunch Rm			
Address:			

Capx Assumptions					
Description	Purchase	5-yr Buyout Lease per Month	5-yr Buyout Lease per Month	Straight Lease/Car Loan	Due At Signing
2021 Chevy Suburban	\$80,593.70			\$1,300.00	\$10,000.00
Pallet Racking System for 20,000-Pallets. Including stamped engineered drawing, installation, freight, tax,	\$1,165,305.00	\$21,767.00	\$19,339.00		
Skid Steer JCB Telescopic 3TS-8W	\$65,000.00			\$1,169.00	
Flexi Narrow Aisle Electric Sit Down Forklift with extra battery and charger	\$84,557.00			\$1,520.00	
FB18MU-12 Komatsu 3-Wheel Sit Down Electric Forklift with extra battery and charger	\$37,984.00			\$673.00	
FG20ST-16 Komatsu 4-Wheel Sit Down LP Forklift	\$25,191.00			\$449.00	
Big Joe D40 Electric Pallet Jack - Required to change out batteries	\$5,000.00			\$99.00	
Liquid Propane Storage Tank \$1,450.00/\$27.00 per month. (Holds 12 tanks)				\$50.00	

Key Notes

Current MBM Biosolids Marketing
Ag: Bulk broadcast applications sold to relatively few accounts with large tracts of land
Nutrients PLUS Marketing
Non Ag: 50 lb. packaging distributed to a multitude of accounts involving smaller properties
Conversion Requires Phased Approach
Dependence on the old approach is driven by a quick fix, disposal philosophy
Non Ag, premium fertilizer selling is a long term, sophisticated marketing process
Three phases define stages for converting lowest value to highest value products
Phase 1: Premium Market Entry Uses 10,000 Tons of Biosolids, 40,000 Tons Sold As Usual
a. Immediate market entry by Nutrients PLUS features blending-bagging Clarus Brand Bags
b. Blending also enhances biosolids sold to farms; ensures volume via bulk applications
c. Private label blending and bagging is not essential but illustrates the model's flexibility
Phase 2: Depicts How Same 10,000 Tons is all Converted to Highest Value Clarus Brand
a. Phase 2 is not a Year 2 Proforma
b. Blending to enhance biosolids as bulk blends to farmers will increase (40,000 decreases)
c. Phase 2 depicts premium extracted by Nutrients PLUS to incentivize the LLC
Phase 3: Depicts All 52,000 Tons of Biosolids Converted to Highest Value Clarus Brand
a. 5-Year Plan
b. Features All Nutrients PLUS Clarus Brand
c. This is the highest value and only possible from Clarus Technology

The following are the Assumptions Seasonal Demands used in formulas



Midwest Blending & Bagging Seasonal Demands and Storage Needs

Project: Midwest Blending & Bagging
 Address: To Be Determined
 Owner: BioSource Nutrients Illinois, LLC
 Architect: Internal Design Team

Maximum and Minimum Pallet Storage Needs Analysis

Month	Seasonal Major Shipment	Combined Sales April/May/June	% of Annual Sales Shipped	Monthly Pallets Sold	% of Monthly Production Shipped	Delta # of Pallets to Monthly Production	Total Stored - Assuming Starting Stock of 24,624 Pallets	Pallets Stored at our Facility Max Storage capability = 16,000-Pallets	Store @ 3rd Party Logistics = Assume Max. Warehouse storage = 16,000 Pallets.
Initial Stock							23,652		
January	Spring	56%	1%	972	12%	7,128	30,780	16,000	14,780
February	Spring		2%	1,944	24%	6,156	36,936	16,000	20,936
March			7%	6,804	84%	1,296	38,232	16,000	22,232
April	Summer		19%	18,468	228%	(10,368)	27,864	16,000	11,864
May	Summer		19%	18,468	228%	(10,368)	17,496	16,000	1,496
June			18%	17,496	216%	(9,396)	8,100	8,100	0
July	Fall		15%	14,580	180%	(6,480)	1,620	1,620	0
August	Fall		10%	9,720	120%	(1,620)	0	0	0
September			5%	4,860	60%	3,240	3,240	3,240	0
October			2%	1,944	24%	6,156	9,396	9,396	0
November			1%	972	12%	7,128	16,524	16,000	524
December	Spring		1%	972	12%	7,128	23,652	16,000	7,652
Totals			100%	97,200		0			

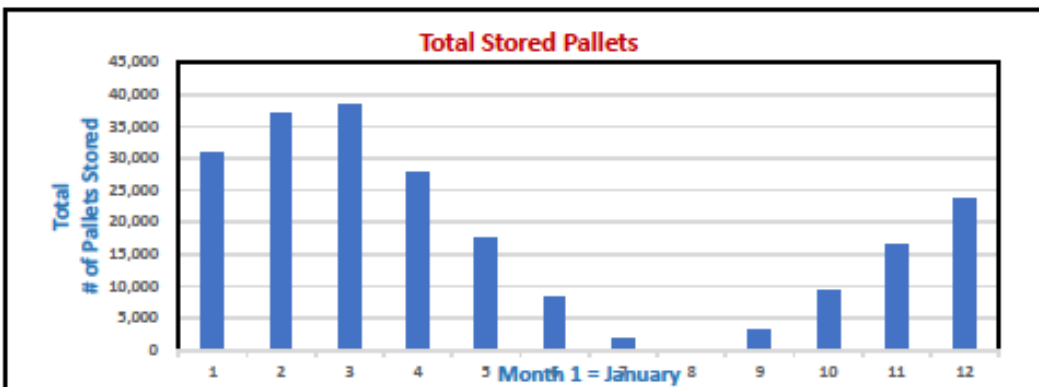
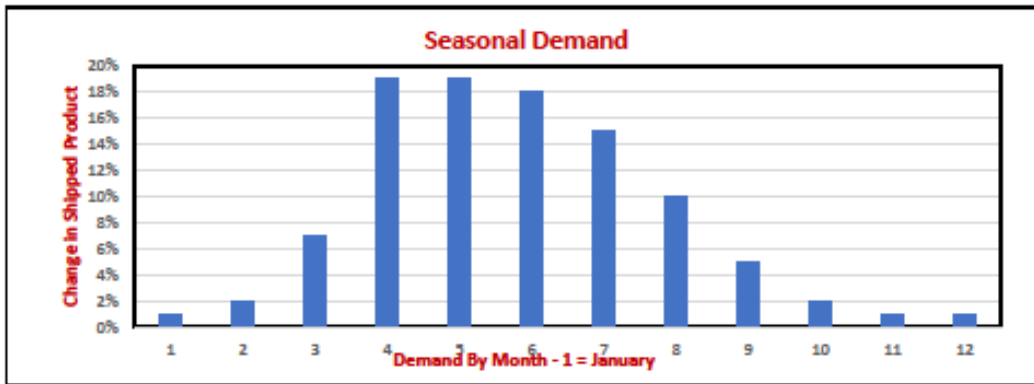

The following are the Assumptions for Production Rates and Crew costs used in formulas

Midwest Blending and Bagging Models - Operating Budgets

Year	Model-1 (Ken's Model)	Model-2	Model-3	Model-4	Model-5	Model-6
	Biosolids Avail. - 38,000 Tons MBnB Takes 0 Tons	Biosolids Avail. - 38,000 Tons MBnB Takes 1,260 Tons	Biosolids Avail. - 38,000 Tons MBnB Takes 1,260 Tons	Biosolids Avail. - 38,000 Tons MBnB Takes 1,260 Tons	Biosolids Avail. - 46,150 Tons MBnB Takes 1,260 Tons	Biosolids Avail. - 47,500 Tons MBnB Takes 1,260 Tons
1	MBnB Takes 10,000 Tons	MBnB Takes 15,000 Tons	MBnB Takes 15,000 Tons	MBnB Takes 20,000 Tons	MBnB Takes 25,000 Tons	MBnB Takes 30,000 Tons
2	MBnB Takes 15,000 Tons	MBnB Takes 26,500 Tons	MBnB Takes 28,000 Tons	MBnB Takes 30,000 Tons	MBnB Takes 32,000 Tons	MBnB Takes 38,000 Tons
3	MBnB Takes 25,000 Tons	MBnB Takes 32,250 Tons	MBnB Takes 35,000 Tons	MBnB Takes 38,000 Tons	MBnB Takes 38,000 Tons	MBnB Takes 46,150 Tons
4	MBnB Takes 38,000 Tons	MBnB Takes 38,000 Tons	MBnB Takes 38,000 Tons	MBnB Takes 41,400 Tons	MBnB Takes 41,400 Tons	MBnB Takes 46,150 Tons
5	MBnB Takes 38,000 Tons	MBnB Takes 38,000 Tons	MBnB Takes 40,500 Tons	MBnB Takes 41,400 Tons	MBnB Takes 46,150 Tons	MBnB Takes 47,500 Tons
6	MBnB Takes 38,000 Tons	MBnB Takes 38,000 Tons	MBnB Takes 40,500 Tons	MBnB Takes 41,400 Tons	MBnB Takes 46,150 Tons	MBnB Takes 47,500 Tons

Year	Model-1 (Ken's Model)	Model-2	Model-3	Model-4	Model-5	Model-6
	Biosolids Avail. - 38,000 Tons MBnB Takes 0 Tons	Biosolids Avail. - 38,000 Tons MBnB Takes 1,260 Tons	Biosolids Avail. - 38,000 Tons MBnB Takes 1,260 Tons	Biosolids Avail. - 38,000 Tons MBnB Takes 1,260 Tons	Biosolids Avail. - 46,150 Tons MBnB Takes 1,260 Tons	Biosolids Avail. - 47,500 Tons MBnB Takes 1,260 Tons
1	MBnB Takes 10,000 Tons	MBnB Takes 15,000 Tons	MBnB Takes 15,000 Tons	MBnB Takes 20,000 Tons	MBnB Takes 25,000 Tons	MBnB Takes 30,000 Tons
2	MBnB Takes 15,000 Tons	MBnB Takes 26,500 Tons	MBnB Takes 28,000 Tons	MBnB Takes 30,000 Tons	MBnB Takes 32,000 Tons	MBnB Takes 38,000 Tons
3	MBnB Takes 25,000 Tons	MBnB Takes 32,250 Tons	MBnB Takes 35,000 Tons	MBnB Takes 38,000 Tons	MBnB Takes 38,000 Tons	MBnB Takes 46,150 Tons
4	MBnB Takes 38,000 Tons	MBnB Takes 38,000 Tons	MBnB Takes 38,000 Tons	MBnB Takes 41,400 Tons	MBnB Takes 41,400 Tons	MBnB Takes 46,150 Tons
5	MBnB Takes 38,000 Tons	MBnB Takes 38,000 Tons	MBnB Takes 40,500 Tons	MBnB Takes 41,400 Tons	MBnB Takes 46,150 Tons	MBnB Takes 47,500 Tons
6	MBnB Takes 38,000 Tons	MBnB Takes 38,000 Tons	MBnB Takes 40,500 Tons	MBnB Takes 41,400 Tons	MBnB Takes 46,150 Tons	MBnB Takes 47,500 Tons

Description	Crew Label			
	A	B	C	D
Blending Operator	1	1	1	1
2nd Shift Blending Operator			1	1
Delivery Haul-Off Operator	1	1	1	1
2nd Shift Delivery Haul-Off Operator			1	1
Forklift Driver -1	1	1	1	1
Forklift Driver -2			1	1
Forklift Driver -3				
2nd Shift Forklift Driver -1			1	1
2nd Shift Forklift Driver -2				
2nd Shift Forklift Driver -3				
Skid Steer Operator	1	1	1	1
2nd Shift Skid Steer Operator			1	1
Maintenance Person - All Around Helper	1	1	1	1
2nd Shift Maintenance Person - All Around Helper			1	1
Total Crew Size all sifts combined	7	8	14	16

Monthly Crew Costs

Crew Label	Maximum Annual Tonnage	Crew Monthly Costs
Monthly Costs Crew=0	0 Tons Per Year	\$0
Monthly Costs Crew-A	20,000 Tons Per Year	\$67,553.4792
Monthly Costs Crew-B	30,000 Tons Per Year	\$76,119.9167
Monthly Costs Crew-C	40,000 Tons Per Year	\$135,106.9583
Monthly Costs Crew-D	50,000 Tons Per Year	\$152,239.8333

The following are the Assumptions for Bagging Machine Rate and Crew Sizes used in formulas

Bagging Line Speed and Crew Req

Units	Per shift @ 8-Bags/Minute	Per shift @ 9-Bags/Minute	Per shift @ 10-Bags/Minute	Per shift @ 12-Bags/Minute	Per shift @ 14-Bags/Minute	Per shift @ 16-Bags/Minute
Crew ID	A	B	C	D	E	F
Number of Shifts per day	1	1	1	1	1	1
Bags per Minute	8.00 Bags/minute	9.00 Bags/minute	10.00 Bags/minute	12.00 Bags/minute	14.00 Bags/minute	16.00 Bags/minute
Bags per hour	480.00	540.00	600.00	720.00	840.00	960.00
Pallets per hour	12.00	13.50	15.00	18.00	21.00	24.00
Minutes per shift	84.00	94.50	105.00	126.00	147.00	168.00
Minutes per pallet	5.00	4.44	4.00	3.33	2.86	2.86
Tons Fin d Product per day	84	95	105	126	147	168
Tons Biosolids Used per day	42	47	53	63	74	84
Tons Biosolids Used per Month	1,260	1,418	1,575	1,890	2,205	2,520
Tons Biosolids Used per year	15,120	17,010	18,900	22,680	26,460	30,240
Pallets per month	2,520	2,835	3,150	3,780	4,410	5,040
Pallets year	181,440	204,120	226,800	272,160	317,520	362,880
Shift Costs per Year	\$605,047	\$605,047	\$605,047	\$800,385	\$800,385	\$800,385
Units						
Crew ID	G	H	J	K	L	M
Number of Shifts per day	2	2	2	2	2	2
Bags per Minute	8.00 Bags/minute	9.00 Bags/minute	10.00 Bags/minute	12.00 Bags/minute	14.00 Bags/minute	16.00 Bags/minute
Bags per hour - This shift	480.00	540.00	600.00	720.00	840.00	960.00
Pallets per hour - This shift	12.00	13.50	15.00	18.00	21.00	24.00
Pallets per shift - This shift	84.00	94.50	105.00	126.00	147.00	168.00
Minutes per pallet - This shift	5.00	4.44	4.00	3.33	2.86	2.50
Tons Fin d Product per day - all shifts combined	168	189	210	252	294	336
Tons Biosolids Used per day - all shifts combined	84	95	105	126	147	168
Tons Biosolids Used per Month - all shifts combined	2,520	2,835	3,150	3,780	4,410	5,040
Tons Biosolids Used per year - all shifts combined	30,240	34,020	37,800	45,360	52,920	60,480
Pallets per month - all shifts combined	5,040	5,670	6,300	7,560	8,820	10,080
Pallets year - all shifts combined	60,480	68,040	75,600	90,720	105,840	120,960
This 2nd Shift Costs per Year only	\$650,426	\$650,426	\$650,426	\$860,413	\$860,413	\$860,413
Annual Costs 2-shifts Combined	\$1,255,473	\$1,255,473	\$1,255,473	\$1,660,798	\$1,660,798	\$1,660,798
Units						
Crew ID	N	O	P	Q	R	S
Number of Shifts per day	3	3	3	3	3	3
Bags per Minute	8.00 Bags/minute	9.00 Bags/minute	10.00 Bags/minute	12.00 Bags/minute	14.00 Bags/minute	16.00 Bags/minute
Bags per hour	480.00	540.00	600.00	720.00	840.00	960.00
Pallets per hour	12.00	13.50	15.00	18.00	21.00	24.00
Pallets per shift	84.00	94.50	105.00	126.00	147.00	168.00
Minutes per pallet	5.00	4.44	4.00	3.33	2.86	2.50
Tons Fin d Product per day - all shifts combined	252	284	315	378	441	504
Tons Biosolids Used per day - all shifts combined	126	142	158	189	221	252
Tons Biosolids Used per Month - all shifts combined	3,780	4,253	4,725	5,670	6,615	7,560
Tons Biosolids Used per year - all shifts combined	45,360	51,030	56,700	68,040	79,380	90,720
Pallets per month - all shifts combined	9,072	8,505	9,150	10,800	12,600	14,400
Pallets year - all shifts combined	\$660,182	\$660,182	\$660,182	\$880,320	\$880,320	\$880,320
This 3rd Shift Costs per Year only	\$1,915,655	\$1,915,655	\$1,915,655	\$2,544,000	\$2,544,000	\$2,544,000
Annual Costs 3-shifts Combined	\$1,915,655	\$1,915,655	\$1,915,655	\$2,544,000	\$2,544,000	\$2,544,000

The following are the Assumptions for Labor Costa and Burdens used in formulas

January 9thn 2021

Sr. Warehouse / Control Room Manager			
Compensation	Value	Value	% of Costs
Base Annual Salary	\$82,500	\$82,500	62.46%
Bonus		\$5,000	3.79%
FICA @ 6.25%		\$5,156	3.90%
Medicare 1.45%		\$1,196	0.91%
Healthcare		\$24,000	18.17%
401K		\$3,300	2.50%
Workman's Comp		\$10,938	8.28%
Total benefits	\$49,590.00		100%
Total Hourly Compensation	\$66.05		
Total Annual Compensation	\$132,090.00	\$132,090.00	
Total Monthly Compensation	\$11,007.50		

Non Union Forklift Driver			
Compensation	Value	Value	% of Costs
Base Hourly Wage	\$78,000.00	\$78,000.00	76%
Health Insurance		\$2,250.00	2%
401K		\$3,510.00	3%
Vacation		\$3,000.00	3%
FICA @ 6.25%		\$4,875.00	5%
Medicare 1.45%		\$1,131.00	1%
Workman's Comp		\$10,031	10%
Sub-Totals	\$78,000.00	\$24,797.25	100%
Total Annual Compensation	\$102,797.25		
Total Hourly Compensation	\$37.50		
Total Monthly Compensation	\$8,566.44		

Jr. Warehouse / Control Room Manager			
Compensation	Value	Value	% of Costs
Base Annual Salary	\$78,000	\$78,000	61.66%
Bonus		\$5,000	3.95%
FICA @ 6.25%		\$4,875	3.85%
Medicare 1.45%		\$1,131	0.89%
Healthcare		\$24,000	18.97%
401K		\$3,120	2.47%
Workman's Comp		\$10,375	8.20%
Total benefits	\$48,501.00		100%
Total Hourly Compensation	\$63.25		
Total Annual Compensation	\$126,501.00	\$126,501.00	
Total Monthly Compensation	\$10,541.75		

Non Union Skid Steer - Blending - Bagging Operator			
Compensation	Value	Value	% of Costs
Base Hourly Wage	\$70,000.00		76%
Health Insurance		\$2,250.00	2%
401K		\$3,150.00	3%
Vacation		\$3,000.00	3%
FICA @ 6.25%		\$4,375.00	5%
Medicare 1.45%		\$1,015.00	1%
Workman's Comp		\$8,750	9%
Sub-Totals	\$70,000.00	\$22,540.00	100%
Total Annual Compensation	\$92,540.00		
Total Hourly Compensation	\$33.65		
Total Monthly Compensation	\$7,711.67		

Regional Manager / Sales Manager			
Compensation	Value	Value	% of Costs
Base Annual Salary	\$245,000	\$245,000	75.99%
Bonus		\$15,000	4.65%
FICA @ 6.25%		\$15,313	4.75%
Medicare 1.45%		\$3,553	1.10%
Healthcare		\$26,400	8.19%
401K		\$9,800	3.04%
Workman's Comp		\$7,350.00	2.28%
Total benefits	\$77,415		100.00%
Total Hourly Compensation	\$161.21		
Total Annual Compensation	\$322,415.00	\$322,415.00	
Total Monthly Compensation	\$26,867.92		

Sales model-1			
Compensation	Value	Value	% of Costs
Base Annual Salary	\$150,000	\$150,000	50.26%
Commissions	\$100,000		33.51%
FICA @ 6.25%		\$9,375	3.14%
Medicare 1.45%		\$2,175	0.73%
Healthcare		\$26,400	8.85%
401K		\$6,000	2.01%
Workman's Comp		\$4,500.00	1.51%
Total benefits	\$48,450		100%
Total Annual Compensation	\$298,450.00	\$198,450.00	
Total Monthly Compensation	\$24,870.83		

Office / Logistics Manager - Executive Level			
Compensation	Value	Value	% of Costs
Base Annual Salary	\$85,000	\$85,000	70.45%
Bonus		\$5,000	4.14%
FICA @ 6.25%		\$5,313	4.40%
Medicare 1.45%		\$1,233	1.02%
Healthcare		\$18,000	14.92%
401K		\$3,400	2.82%
Workman's Comp		\$2,700	2.24%
Total benefits	\$35,645.00		100.00%
Total Hourly Compensation	\$60.32		
Total Annual Compensation	\$120,645.00	\$120,645.00	
Total Monthly Compensation	\$10,053.75		

Sales model-2			
Compensation	Value	Value	% of Costs
Base Annual Salary	\$150,000	\$150,000	75.59%
Commissions	\$0		0.00%
FICA @ 6.25%		\$9,375	4.72%
Medicare 1.45%		\$2,175	1.10%
Healthcare		\$26,400	13.30%
401K		\$6,000	3.02%
Workman's Comp		\$4,500.00	2.27%
Total benefits	\$48,450		100%
Total Annual Compensation	\$198,450.00	\$198,450.00	
Total Monthly Compensation	\$16,537.50	Plus Monthly Commissions	

Adminstrative Assistant			
Compensation	Value	Value	% of Costs
Base Annual Salary	\$50,000	\$50,000	63.74%
Bonus		\$3,000	3.82%
FICA @ 6.25%		\$3,125	3.98%
Medicare 1.45%		\$725	0.92%
Healthcare		\$18,000	22.95%
401K		\$2,000	2.55%
Workman's Comp		\$1,590	2.03%
Total benefits	\$28,440.00		100.00%
Total Hourly Compensation	\$39.22		
Total Annual Compensation	\$78,440.00	\$78,440.00	
Total Monthly Compensation	\$6,536.67		

Union Forklift Driver - Operating Engineer Building Class-2 Chicago			
Compensation	Value	Value	% of Costs
Base Hourly Wage	\$50.80	\$50.80	49%
Health and Welfare		\$20.90	20%
Pension		\$17.85	17%
Vacation		\$2.00	2%
Training		\$2.15	2%
FICA @ 6.25%		\$3.18	3%
Medicare 1.45%		\$0.74	1%
Workman's Comp		\$6	
Total benefits	\$53.16		
Total Hourly Compensation	\$103.96	\$103.96	\$0.94
Total Annual Compensation	\$207,923.20	\$207,923.20	\$1,877.84
Total Monthly Compensation	\$17,326.93		

Foreman Union Forklift Driver - Operating Engineer Building Class-2 Chicago			
Compensation	Value	Value	% of Costs
Base Hourly Wage	\$56.10	\$56.10	51%
Health and Welfare		\$20.90	19%
Pension		\$17.85	16%
Vacation		\$2.00	2%
Training		\$2.15	2%
FICA @ 6.25%		\$3.51	3%
Medicare 1.45%		\$0.81	1%
Workman's Comp		\$7	
Total benefits	\$54.23		
Total Hourly Compensation	\$110.33	\$110.33	\$0.94
Total Annual Compensation	\$220,664.40	\$220,664.40	\$1,872.88
Total Monthly Compensation	\$18,388.70		

Union Skid Steer Driver - Operating Engineer Building Class-4 Chicago			
Compensation	Value	Value	% of Costs
Base Hourly Wage	\$46.50	\$46.50	47%
Health and Welfare		\$20.90	21%
Pension		\$17.85	18%
Vacation		\$2.00	2%
Training		\$2.15	2%
FICA @ 6.25%		\$2.91	3%
Medicare 1.45%		\$0.67	1%
Workman's Comp		\$5.81	
Total benefits	\$52.29		
Total Hourly Compensation	\$98.79	\$98.79	\$0.94
Total Annual Compensation	\$197,586.00	\$197,586.00	\$1,882.33
Total Monthly Compensation	\$16,465.50		

Foreman Union Skid Steer Driver - Operating Engineer Building Class-4 Chicago			
Compensation	Value	Value	% of Costs
Base Hourly Wage	\$56.10	\$56.10	51%
Health and Welfare		\$20.90	19%
Pension		\$17.85	16%
Vacation		\$2.00	2%
Training		\$2.15	2%
FICA @ 6.25%		\$3.51	3%
Medicare 1.45%		\$0.81	1%
Workman's Comp		\$7.01	
Total benefits	\$54.23		
Total Hourly Compensation	\$110.33	\$110.33	\$0.94
Total Annual Compensation	\$220,664.40	\$220,664.40	\$1,872.88
Total Monthly Compensation	\$18,388.70		

Union Truck Driver 5-axil Class-3 Chicago			
Compensation	Value	Value	% of Costs
Base Hourly Wage	\$41.05	\$41.05	\$0.63
Health and Welfare		\$9.90	\$0.15
Pension		\$10.64	\$0.16
Vacation		\$0.00	\$0.00
Training		\$0.15	\$0.00
FICA @ 6.25%		\$2.57	4%
Medicare 1.45%		\$0.60	1%
Workman's Comp		\$5.13	
Total benefits	\$28.98		
Total Compensation	\$70.03	\$64.90	\$1.00
Total Annual Compensation	\$140,064.20	\$129,801.70	\$2,000.00
Total Monthly Compensation	\$11,672.02		

Foreman Union Truck Driver 5-axil Class-3 Chicago			
Compensation	Value	Value	% of Costs
Base Hourly Wage	\$41.25	\$41.25	\$0.63
Health and Welfare		\$9.90	\$0.15
Pension		\$10.64	\$0.16
Vacation		\$0.00	\$0.00
Training		\$0.15	\$0.00
FICA @ 6.25%		\$2.58	4%
Medicare 1.45%		\$0.60	1%
Workman's Comp		\$5.16	
Total benefits	\$29.02		
Total Compensation	\$70.27	\$65.12	\$1.00
Total Annual Compensation	\$140,545.00	\$130,232.50	\$2,000.00
Total Monthly Compensation	\$11,712.08		

Union Truck Driver 5-axil Class-3 Chicago			
Compensation	Value	Value	% of Costs
Base Hourly Wage	\$41.05	\$41.05	63%
Health and Welfare		\$9.90	15%
Pension		\$10.64	16%
Vacation		\$0.00	0%
Training		\$0.15	0%
FICA @ 6.25%		\$2.57	4%
Medicare 1.45%		\$0.60	1%
Workman's Comp		\$5.13	
Total benefits	\$28.98		
Total Compensation	\$70.03	\$64.90	100.00%
Total Annual Compensation	\$140,064.20	\$129,801.70	
Total Monthly Compensation	\$11,672.02	Hourly + 18% MU	
Total Monthly Compensation + 18% MU	\$13,772.98		

Non-Union Truck Driver 5-axil			
Compensation	Value	Value	% of Costs
Base Annual Salary	\$75,000	\$75,000	64.98%
Bonus/Vacation		\$3,000	2.60%
FICA @ 6.25%		\$4,688	4.06%
Medicare 1.45%		\$1,088	0.94%
Healthcare		\$26,400	22.87%
401K		\$3,000	2.60%
Workman's Comp		\$2,250.00	1.95%
Total benefits	\$40,425		100.00%
Total Hourly Compensation	\$57.71	Hourly + 18% MU	\$68.10
Total Annual Compensation	\$115,425.00		
Total Monthly Compensation	\$9,618.75		
Total Monthly Compensation - + 18% MU	\$11,350.13		

The following are the Assumptions for Electrical Costs used in formulas

*Midwest Blending and Bagging
Assumptions - Electrical Costs*

CUSTOMER		Midwest Blending and Bagging			SUBJECT		Electrical Load			DATE
JOB NUMBER		201109C1								4/5/2021
PAGE	1	OF	1	PREPARED BY	JJS	CHECKED BY				
Process Motor List					HP					
Sackett Model BT250 Bulk-Toter Cnvyr	15					Power Needed				
Sackett Mdl BE200 Cntrfgl Blt Bckt Elev	25									
Sackett 24" Fxd Frm Trprpr Blt Cnvyr	15					Day Shift	600	kW hr		
Electric Winch	1.5					Night Shift	600	kW hr		
(2) Micro Weigh Hoppers	6					Per Day	900	kW hr		
Sackett Mdl BT250 BlkTtr Chain Cnvyr	40									
Sackett Drct Dr Oblt Blndr	40					\$7.37		kW hr		
Sackett Mdl BE250 Cntrfg Blt Bckt Elev	25						16	hrs		
Total	168					\$117.92		Day		
Assumption Monthly Electrical Costs						\$3,537.60				
APC Motor List					HP					
ID Fan	75									
Rotary Air Lock	3									
Compressor	20									
Total	98									
HVAC/Ventilation					HP					
Air Handlers	50									
HVAC 30 Ton	100									
Total	150									
Bagging/Palletizing					HP					
	20									
Total	436				HP					
	516				Amps					
Lighting					500	Amps				
Total Service					1,016	Amps				

Capital Budget



Midwest Blending & Bagging
Conceptual Design Budget

Project: Midwest Blending & Bagging
Address: To Be Determined
Owner: BioSource Nutrients Illinois, LLC
Architect: Internal Design Team

Project Number: MBB-1001
Attn: Project Sponsors
Plans Date: Current
Pricing Submission Date: 12/20/2020

Executive Cost Summary

Item #	Breakdown		Midway	Weitz
1	Interior Build Out	\$1,203,920	\$1,565,096	\$1,878,115
4	Equipment	\$4,618,373	\$4,618,373	\$4,618,373
5	Add 2nd Blend Line	\$0		
6	General Conditions	\$467,900	\$467,900	\$1,271,485
2	Trade Requirements	\$0		\$20,093.99
9	Safety	\$0		\$16,413
3	Misc. Equipment	\$0		\$29,835
6	Design - Arch, MEP, Interior	\$67,850	\$67,850	
7	Design - Process Integration	\$146,000	\$146,000	\$455,555
7	Design - Air Quality Control Systems and Mechanical	\$75,000	\$75,000	
8	Weaver - EPA Permit Preparation	10,000	\$10,000	\$10,000
9	Permits	70,500	\$70,500	
10	Contingency	8% \$499,466	8% \$561,658	8% \$663,990
11	GC Ins	= \$12.5/1000 \$89,488	= \$12.5/1000 \$94,780	= \$12.5/1000 \$112,048
12	Gc Fee - In House	0% \$0	8% \$575,787	8% \$680,693
Sub-Total Design Build Company Costs		\$7,248,497	\$8,252,943	\$9,756,601

Analysis and Breakdown of Costs by Area
Permits and Permit Drawings

Item	Description	Base Cost		Notes
13	Estimated Local Permit	40,000		
14	Estimated Permit Procurement	3,500		
15	Expedite EPA Air Permit	25,000		
16	Cook County Air Permit	2,000		
Permit Total		70,500		

Equipment

Item	Description	Base Cost		Notes
17	Truck Scale	95,000	95,000	95,000
18	Air Compressor - Including pipe and fittings 2" Lines	6,500	6,500	6,500
19	Air Scrubber and Dust Control	800,000	800,000	800,000
20	Install Air/Duct Equip + F/I Ducts Sys	400,000	400,000	400,000
21	Mechanical and Air Quality Controls	300,000	300,000	300,000
22	Sackett Waconia Blending Equipment Total	840,800	840,800	840,800
23	Sackett Waconia Freight Budget	35,000	35,000	35,000
24	Sackett Waconia Critical Spare Parts	20,000	20,000	20,000
25	Liquid Impregnation Equipment	9,500	9,500	9,500
26	Sackett Waconia Micro Hopper - fed by big bags	17,500	17,500	17,500
27	Sackett Waconia Bagging Hopper with Structure and level switches	22,000	22,000	22,000
28	Tax Sackett Equip	66,003	66,003	66,003
29	Equipment Installation - Budget	140,000	140,000	140,000
30	Misc. Metal Supports NIC in Sackett	40,000	40,000	40,000
31	Cast Covers/Angles/Grates NIC in Sackett	15,000	15,000	15,000
32	Fischbein Inglett Bagging Equipment	620,620	620,620	620,620
33	Startup Services	62,000	62,000	62,000
34	Sales Tax -Fischbein	48,719	48,719	48,719
35	Fischbein Equipment Installation	65,000	65,000	65,000
36	Custom Precast Concrete Major Supply Bins	257,483	257,483	257,483
37	Tax @ Custom Precast Concrete Major Supply Bins	20,599	20,599	20,599
38	Major Equipment Controls Integration	75,000	75,000	75,000
39	Decking Major Supply Bins	175,000	175,000	175,000
40	Concrete - Custom Pit @ Receiving Hopper and Blending	35,000	35,000	35,000
42	Concrete - Out-Building Slab, Foundations and Footings	101,650	101,650	101,650
41	Outbuilding	150,000	150,000	150,000
43	Commissioning	200,000	200,000	200,000
Subtotal Equipment		\$ 4,618,373	\$ 4,618,373	\$ 4,618,373



Midwest Blending & Bagging Conceptual Design Budget

Project: Midwest Blending & Bagging
 Address: To Be Determined
 Owner: BioSource Nutrients Illinois, LLC
 Architect: Internal Design Team

Project Number: MBB-1001
 Attn: Project Sponsors
 Plans Date: Current
 Pricing Submission Date: 12/20/2020

Interior Work

Item	Description	Base Cost		Notes
44	Security - Construction and Permanent	0	0	
45	Temp Power and Temp Lighting	2,800	2,800	
46	Demolition	3,500	3,500	
47	Concrete Cut	0	0	
48	Concrete Patch	2,500	2,500	
49	Concrete Leveling and Floor Patch	1,000	1,000	
50	Misc. Metal Supports @ RTU's	6,000	6,000	
51	Rough Carpentry	1,000	1,000	
52	Finish Carpentry	1,500	1,500	
53	Lunchroom Cabinetry - Production	4,500	4,500	
54	Millwork - Lunchroom Admin Staff	0	0	
55	Toilet room Vanity Tops	1,500	1,500	
56	Shelving - Coat Shelf and Rod	450	450	
57	Wall Insulation - 9-ft	2,500	2,500	
58	Wall Insulation - 32-ft	5,120	5,120	
59	Cut Roof/Deck and Patch for RTU's	9,500	9,500	
60	Fire Stopping	5,500	5,500	
61	Overhead Rolling Shutter Doors	10,000	10,000	
62	H.M. Single Doors & Frames & Hrdw - Production	12,600	12,600	
63	Double H.M. Doors & Frames & Hrdw - Production	2,500	2,500	
64	Emergency Exits - H.M. Doors & Frames & Hrdw - Cut into Precast	22,800	22,800	
65	Admin H.M. Wood Doors & Frames & Hrdw	0	0	
66	Windows - Interior Observation	21,000	21,000	
67	Windows - Exterior	0	0	
68	Entrance Storefronts	0	0	
69	750 lf 32-ft high Metal Studs & DW	131,250	131,250	
70	100-lf 10-ft high Metal Studs & DW	9,000	9,000	
71	Access Panels	0	0	
72	Seal Warehouse Floors	0	0	
73	Production Lunchroom, toilet/locker rooms - Flooring	5,500	5,500	
74	Ceramic Tile - Admin Toilet Rooms	0	0	
75	Ceramic Tile - Production Shower walls	7,500	7,500	
76	VCT base - Production Toilet Rooms and Locker Areas	1,800	1,800	
77	Resilient Base Admin Areas	0	0	
78	Carpet - Admin Office Area = 3,600-sf, 400-sy	0	0	
79	Acoustical Ceilings Production Lunch Rm, Locker/Toilet	3,500	3,500	
80	Acoustical Ceilings Admin Office	0	0	
81	Paint Interior	35,000	35,000	
82	Paint Exterior	0	0	
83	Toilet Partitions	3,500	3,500	
84	Fire Extinguishers & Cabinets	5,500	5,500	
85	Toilet Accessories	3,200	3,200	
86	Shower Doors	1,800	1,800	
87	Plumbing	125,000	125,000	
88	Fire Sprinkler System	225,000	225,000	
89	Base Building Mechanical Systems - Inc. Controls	75,000	75,000	
90	New Electrical Service 800 amp to 1200 Amp	125,400	125,400	
91	Electrical - Equipment Connections, Controls and Wiring	117,200	117,200	
92	Light Fixtures	20,000	20,000	
93	Lighting and Wiring	110,000	110,000	
94	Hvac connections	10,000	10,000	
95	Production Locker rooms and Lunchroom	8,000	8,000	
96	Office modifications	9,500	9,500	
97	Fire Alarm Upgrades	55,000	55,000	
Subtotal Public Space		\$ 1,203,920	\$1,203,920	



Midwest Blending & Bagging Conceptual Design Budget

Project: Midwest Blending & Bagging
Address: To Be Determined
Owner: BioSource Nutrients Illinois, LLC
Architect: Internal Design Team

Project Number: MBB-1001
Attn: Project Sponsors
Plans Date: Current
Pricing Submission Date: 12/20/2020

Construction General Conditions

Item	Description	Base Cost	Cost	Notes
Project Management				
Item	Description	Cost	Cost	Cost
98	Project Manager	225,000	225,000	
99	Superintendent	140,000	140,000	
100	Site Secretary	60,000	60,000	
101	Project Accounting	10,000	10,000	
102				
Sub-Total Project Management Team		\$ 435,000	\$ 435,000	
Temporary Provisions				
Item	Description	Cost	Cost	Cost
103	Site Security	0	0	
104	Field Office / Set Up	1,500	2,500	
105	Field Office Equipment & Supplies	800	1,500	
106	11 x 17 inch Laser Printer	1,900	0	
107	Zerox Rental	0	950	
108	Postage/Fed Ex/Messenger	750	1,500	
109	Blue Prints	1,100	1,500	
110	Attorney Fees	0	10,000	
111	Office Water	600	750	
112	Computers, Software, IT Support	6,500	3,500	
113	Wi-Fi	1,800	1,800	
114	Cell Phones	1,800	3,600	
115	Equipment / Small Tools	1,500	0	
116	Equipment Rentals	2,000	0	
117	Dumpsters Regular Const	5,250	7,800	
118	Final Cleaning	1,200	1,200	
119	Temp Gas, Water, Electric	0	0	
120	Port - O - Lets	1,400	1,400	
121	Temp Fence	0	0	
122	Photos	0	0	
123	Storage Containers	1,500	1,500	
124	Project Signs / Directional	300	350	
125	Temp Barricades / Protection	2,500	2,500	
126	Owner Meeting	0	0	
127	Safety First Aid Kits	500	500	
Sub-Total In House Temporary Provisions		\$32,900	\$42,850	
Total In-House General Conditions		\$467,900	\$ 477,850	



Midwest Blending & Bagging
Conceptual Design Budget

Project: Midwest Blending & Bagging
Address: To Be Determined
Owner: BioSource Nutrients Illinois, LLC
Architect: Internal Design Team

Project Number: MBB-1001
Attn: Project Sponsors
Plans Date: Current
Pricing Submission Date: 12/20/2020

Immediate - Cap-X Not Included in Construction Costs

Item	Description	Base Cost			Notes
128	Pallet Rack Storage Systems	400,000			
129	Counter Weight Forklift	750,000			
130	Narrow Aisle Forklift	50,000			
131	Bobcat	50,000			
132	Project Vehicle	75,000			
133	Building Security and CCTV 40 cameras 2MP	40,000			
134	Card Access control 4 doors	14,000			
135	Office Furniture	8,000			
136	Office Supplies	2,500			
137	Shop Supplies	5,000			
Subtotal Cap-X		\$ 1,394,500			

Q4 - Cap-X Not Included in Construction Costs

Item	Description	Base Cost			Notes
138	Add 2nd Bagging Line	725,000			
139	Pallet Rack Storage Systems	400,000			
140	Counter Weight Forklift-1 Req	750,000			
141	Narrow Aisle Forklift-1 Req	50,000			
142	Bobcat	50,000			
143	EM Generator 150kVA diesel, partial building	70,000			
Subtotal Cap-X		\$ 2,045,000			



Sales and Marketing Plan

Under the leadership of OT&T and Chuck Paulson, Joe Volini and Bart R. Lynam will execute the Sales and Marketing plan penetrating existing and new markets throughout the United States.

Sales Summary

1. We are [REDACTED]
2. Selling a Quality Blended Fertilizer Product
3. Our product line is "Screaming Green"
4. We Pride Our Quality
5. Selling Consumer Packaged Product and Bulk Product

Timing and Goals of Our Sales Plan

1. To acquire Customer Commitments and Purchase Orders
2. Active Construction with a Firm Completion Date
3. Sales Goals need to Account for the OT&T payoff obligations,
4. Immediately Maximize Sales Revenues the Day we Commission the Facility and Shorten the Pay-Off Period.
5. Take Advantage of the Fall 2021 Sales Season!
6. Assume a Sales and Marketing lead time to Our Vendors of 5-Months and an Operational Plant as of 8/14/2021
7. Engage Our Sales and Marketing Plans +/- Mid-March 2021
8. Quality Assurance and Sales go Hand-in-Hand

The Unified Team Approach

- Emphasis on Project Team Building - following the lead of Mr. Chuck Paulson
- A Strong Team Experience Delivering Long-Term Balanced Sales
- Ongoing Training and E-Learning
- Continued and ongoing Interaction between Executive Management and the Sales Team
- Sharing what Works within our Team

Timing and Goals of Our Sales Blitz

- We need to Ensure there is Adequate Shelved Stock to meet Seasonal Demands.

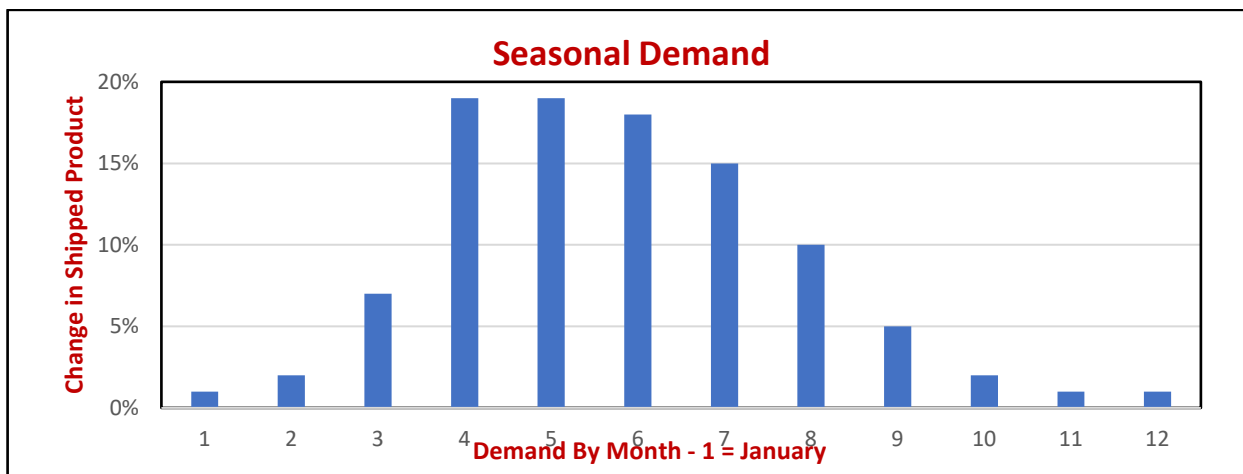

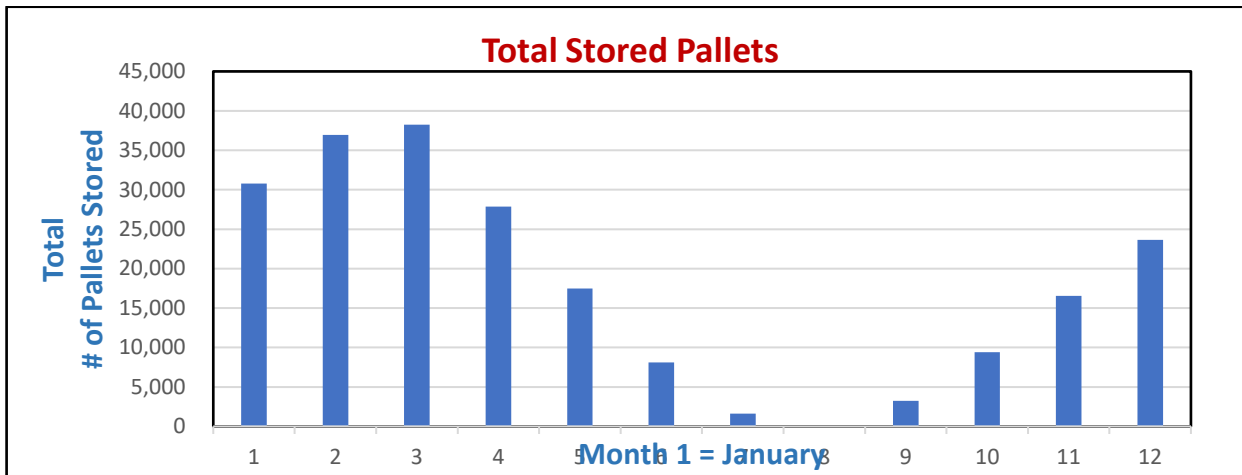

Current Sales and Approach

1. Clarius is ready to build on its current sales base in 47-States. Their experienced sales staff has worked with their key points of sale, making ready to increase PO's as new production is available.
2. Current Sales Volume
3. Current Sales Staff and Territories
4. Current Areas of Improvement
5. Current Sales Capacity – Will Current Production allows for additional sales?
6. What is the current Sales Strategy to go from \$5mm to \$40mm annually

Balancing Two Opposing Risks

- ***Overselling production and not meeting delivery Commitments***
Long Term Damage to a customer relationship
- ***Balanced Sales Goals***
Balancing cash Flow, Production, Stock, Sales

As we advance to Absorb New Production

1. ***Service and Enhance Relationships with Existing Vendors***
2. ***Secure new Sales level with Existing Vendors***
3. ***Aggressive Sales to Acquire New Customers***
4. ***Continued Sales Training and New Approaches***
5. ***Do we want to consider International Sales – Canada, Mexico, Europe***

Existing and Future Customers

1. **Site One Landscape Supply – 496 Locations**
2. **Ewing Irrigation & Landscape Supply – 235 Locations**
3. **Home Depot - 2285 locations**
4. **Rural King Supply – 116 Locations**
5. **Tractor Supply – 1181 Locations**
6. **Menards - 350 locations**
7. **Ace Hardware 5000 locations**
8. **Mid-States Distributing small and medium rural farm stores - +/- 700 Locations**
9. **A.G. Processing #5 Farm co-op in the U.S.**

Points of Sale

Site One Landscape Supply

With 496 – Locations Nationwide



Stronger Together

Alabama (6)	Illinois (14)	New Hampshire (2)	South Dakota (1)
Alaska (0)	Indiana (9)	New Jersey (17)	Tennessee (11)
Arizona (7)	Iowa (3)	New Mexico (1)	Texas (39)
Arkansas (1)	Kansas (6)	New York (19)	Utah (3)
California (68)	Kentucky (3)	North Carolina (28)	Vermont (0)
Colorado (8)	Louisiana (2)	North Dakota (1)	Virginia (15)
Connecticut (14)	Maine (1)	Ohio (14)	Washington (10)
Delaware (2)	Maryland (10)	Oklahoma (5)	West Virginia (0)
District of Columbia (0)	Massachusetts (21)	Oregon (4)	Wisconsin (5)
Florida (47)	Michigan (20)	Pennsylvania (11)	Wyoming (0)
Georgia (16)	Minnesota (6)		
Hawaii (1)	Mississippi (1)		
Idaho (5)	Missouri (8)		

EWING Irrigation & Landscape Supply

With 235 – Locations Nationwide Ewing Irrigation & Landscape Supply is the largest family-owned supplier of landscape and irrigation products in the country.

Ewing supplies professional contractors with irrigation supplies, water efficient and sustainable solutions, landscape and turf products, agronomics and growing, hardscape and outdoor living, landscape lighting, water features, erosion control and more. Ewing also offers industry-leading training classes and events for professionals in the landscaping, sports field, and grower industries.



golf

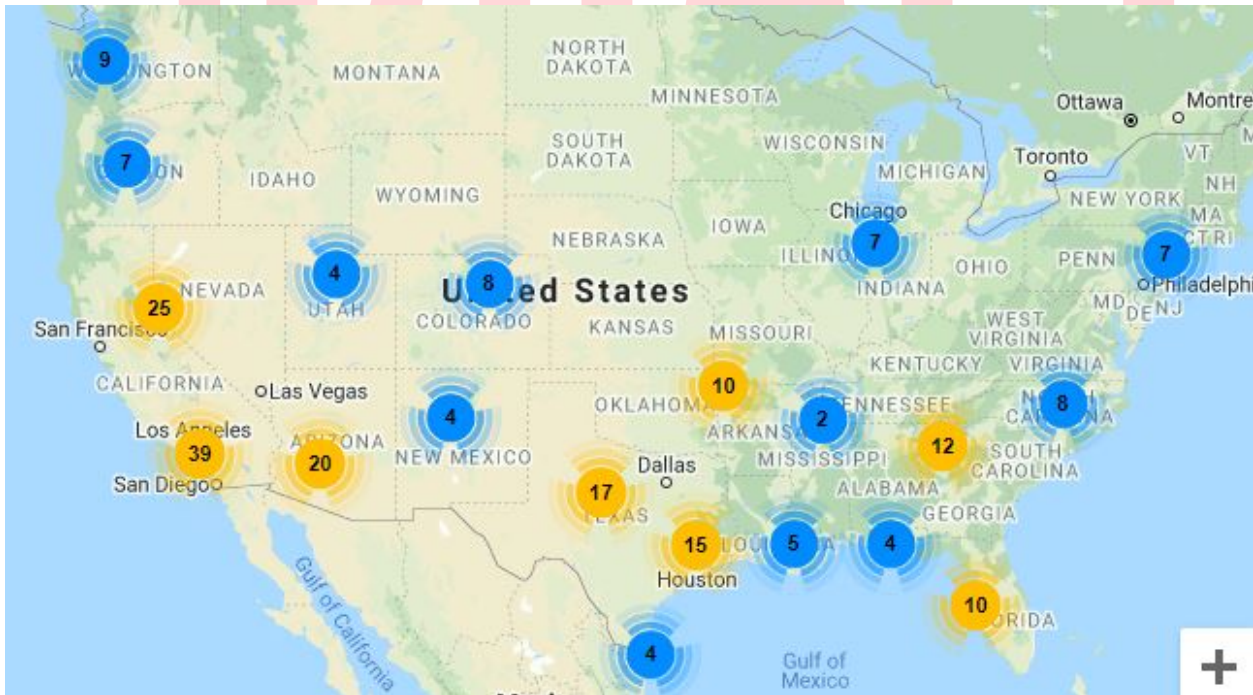

Home

Depot

With 2285 – Locations Nationwide

Headquarter:
2455 Paces Ferry Road
Atlanta, GA 30339 United States
1-770-433-8211.

https://hdapps.homedepot.com/ItemSub_UI/EnterItem.html

Rural

King

Supply

With 116 – Locations Nationwide

Rural King Supply is a farm supply store based in Mattoon, Illinois, United States. Founded in 1960, it now has 116 stores in the U.S

Rural King, also known as R.K. Holdings, L.L.P., is America's Farm and Home Store, a General Merchandise Store, providing essentials to the communities we serve. More specifically, we provide a broad range of necessities, essential goods, food, feed, seed, and other farm, and home products. Rural King planted its roots in Mattoon, Illinois, in 1960. Since that time, Rural King has added over 100 stores in a thirteen-state area (Alabama, Illinois, Indiana, Kentucky, Tennessee, Ohio, Michigan, Missouri, Pennsylvania, Florida, North Carolina, West Virginia, and Virginia). The heart of Rural King is the corporate office, distribution center, and flagship store, located in its city of origin, Mattoon, IL.

In 1979, Gary Melvin, nephew of Kermit Speer, purchased an interest in Rural King. Gary began his career working in the store, learning the products, and serving customers. Today he is C.E.O. and co-owner of the 46 Rural King stores and trucking company.

Headquarter

216 DeWitt Avenue
Mattoon, IL, United States, 61938.

<https://www.ruralking.com>

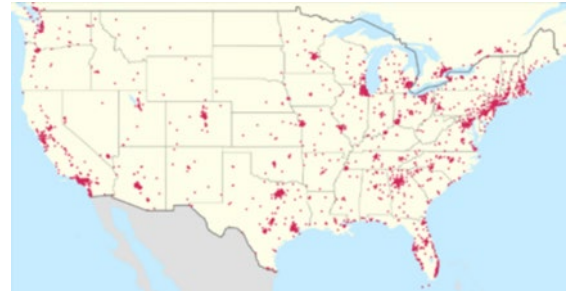

Tractor

Supply

With 1,181 – Locations Nationwide

Introduction to Tractor Supply

The first Tractor Supply store opened in 1938 in Minot, North Dakota. Today, there are 1,881 Tractor Supply stores in 49 states and 180 Pet sense stores in 25 states. To find the Tractor Supply store nearest you, visit our Store Locator.

Headquarter

5401 Virginia Way
Brentwood
TN 37027
877-718-6750

https://www.tractorsupply.com/tsc/store_Fortgratit-MI-48059_177



Menards

With 316 – Locations Nationwide

A family-owned company started in 1958, Menards® is headquartered in Eau Claire, Wisconsin and has more than 300 home improvement stores located in Illinois, Indiana, Iowa, Kansas, Kentucky, Michigan, Minnesota, Missouri, Nebraska, North Dakota, Ohio, South Dakota, Wisconsin, and Wyoming. John Robert Menard Jr. (born January 22, 1940) is an American billionaire businessman, philanthropist, and the founder and owner of Menards, a Midwestern chain of home improvement stores. He is a former INDYCAR racing team owner, and the father of former NASCAR Cup Series driver Paul Menard.



1. Ace Hardware

5000 – Locations Nationwide

Ace retailers are the owners of the corporation and can customize offerings based on customer needs. Owners reap the benefits of a global brand with collective buying power with independent ownership. Retailers pay no royalty fees, and a portion of the profits get distributed back to them each year. Ace is the largest retailer-owned hardware cooperative globally with more than 5,200 locally owned and operated hardware stores in approximately 70 countries. Headquartered in Oak Brook, Ill., Ace, and its subsidiaries operate an expansive network of distribution centers in the U.S. and have distribution capabilities in Ningbo, China; Colon, Panama; and Dubai, United Arab Emirates. Since 1924, Ace has become a part of local communities worldwide and known as the place with the helpful hardware folks. For more information, visit acehardware.com or newsroom.acehardware.com

<http://www.acehardware-vendors.com/>

http://www.acehardware-vendors.com/locations/become_an_ace_supplier/vendor_manual/pdfs/vendor-manual.pdf

Ace Hardware Corporate Headquarters
2200 Kensington Ct,
Oak Brook, IL 60523
(630) 990-6600

Mid-States Distributing small and medium rural farm stores
With 700 – Locations Nationwide

Founded in 1954, Mid-States Distributing Company has become one of the nation's largest retailers in the farm store channel. Mid-States currently has 36 members, employing over 30,000 associates, with approximately 700 store locations in 33 states and 5 Canadian provinces with annual sales in excess of 6.5 billion dollars.

Markets

Farm retail markets differ from county to county and state to state.

Our member-owners work with many markets, including:

COUNTRY D.I.Y.
FARMERS & RANCHERS
HORSE-WOMAN
OUTDOORSMAN
PET/ANIMAL OWNER
RECREATIONAL FARMERS
RURAL HOMEOWNERS

Headquarters

Mid-States Distributing, LLC
2800 Meacham Blvd,
Fort Worth, TX 76137

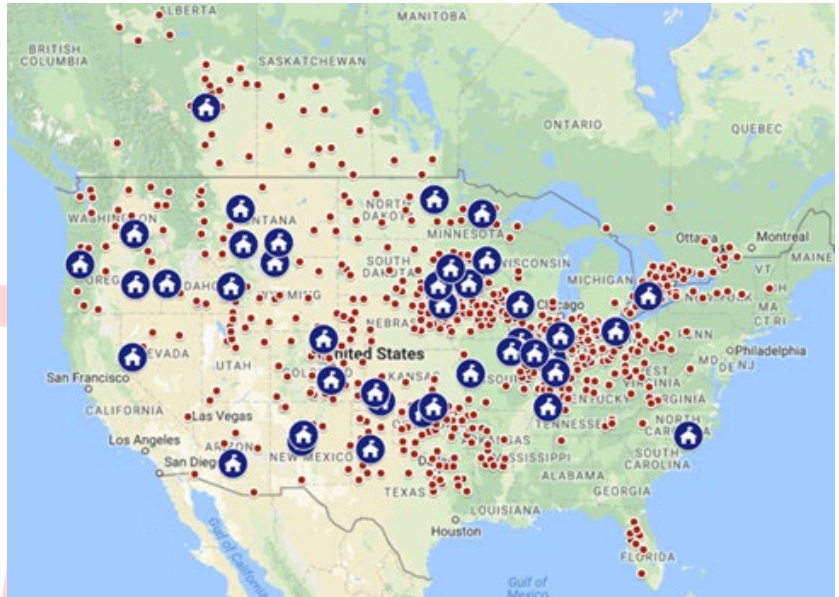

A.G. Processing #5 Farm co-op in the U.S.

Contacts to Large Soybean Farm Co-Ops Nationally

Ag Processing Inc (AGP®) is a leading agribusiness engaged in procuring, processing, marketing, and transporting oilseeds, grains, and related products. Since its creation in 1983, A.G.P. has grown in size, scope, and reputation – both in the U.S. and internationally. Today, our owners include 145 local and regional cooperatives representing more than 250,000 farmers throughout the U.S. and Canada. The Company's businesses include soybean processing, vegetable oil refining, renewable fuels, ag products/grain, and international operations.

A.G.P. is the largest cooperative soybean processing company globally and a leading supplier of soybean meal and refined vegetable oils. We operate ten soybean processing plants in Iowa, Minnesota, Missouri, Nebraska, and South Dakota, as well as four soybean oil refineries and three biodiesel production facilities. In addition to our commodity-based products, A.G.P.'s branded products include SoyGold® (biodiesel) and AminoPlus® (bypass protein).

A.G.P.'s primary mission is to serve cooperatives and agricultural producers by procuring, processing, and marketing agricultural products, both domestically and globally. "Partners in Food Production" illustrates A.G.P.'s longtime commitment to working in collaboration with stockholders and stakeholders including our

loyal employees. Together, we help producers earn more as we successfully manage our owners' investments. Our export programs link farmers to markets around the world. At A.G.P., our Company's culture reflects the agricultural values and hard work that our owners put forth every day.

Headquarters

12700 West Dodge Rd.
Omaha, NE 68154
Phone: 402-496-7809

DRAFT

Inventory and Warehouse Controls

Process controls integrated with Logistics & Warehouse IT Systems are essential to a smooth manufacturing process.

We are designing an automation and control system engineering framework ensuring smooth operations.

We are designing for multiple situation scenarios to not only achieve efficient start-up and shut-down of the systems but to protect persons and equipment in the event of outside failures.

Considerations:

- Power Failures
- IT crashes
- Personelle Injuries anywhere along the process lines
- Equipment failure anywhere in the various process lines
- Fire Alarms
- Material Contamination Issues

We implemented Maintenance Monitoring into the control modules systems logic similar to the “Change Oil Light” indicator light in your car. Maintenance platforms predict failures and indicate routine parts replacement avoiding untimely breakdown or equipment damage.

Relevant acronyms and terminology:

Industrial Automation and Control Systems (**IACS**)

Operational Technology (**OT**)
cyber-physical systems (**CPS**).

Industrial internet of things (**IIoT**)

Internet of Things (**IoT**)

Cyber-Physical Systems (**CPS**)

Industrial Control Systems (**ICS**)

Supervisory Control and Data Acquisition (**SCADA**)

IT and Communications Systems

We are designing an integrated process and office IT system. Included are standard office IT and communication systems, including WIFI, routers, hubs, cabling, phones, printers, and workstations. We are designing industry-standard IT security protocols and internal security protocols to ensure uninterrupted smooth communications.

The production facility, the production office, and remote offices will communicate thru an integrated IT system interfacing Sales, Logistics, Inventory, Production Consumables, Payroll, Keycards, etc. This warehouse management system (WMS) will track inventory and supplies as they move through our warehouse and distribution center. Also, our WMS must make specific processes, such as receiving, picking, and putting away products, faster and more accurate.

Our chosen IT management system must manage sales orders across all sales channels – web orders, call orders, B2B portal, or marketplace orders.

Our IT system must ensure accuracy, efficiency, and timeliness through ILIANA Policies Procedures and Methodologies that meeting our unique needs.

Our systems need to automate cross channel order entry into 3PL fulfillment warehouses.



- Monitor when employees enter and exit the Facility and received detailed reports
- Elevate employee safety
- Immediately restrict access for former employees
- Eliminate misplaced or duplicated keys

System administrators can view open and close reports online. Managed access control is a great way to solve lost or stolen key issues. 24/7 key card access combined with video cameras adds a more secure method of door entry. Interior and exterior door readers can be accessed using a badge, key card, or fob.

Logistics

Direct in-House Logistics

The current Model under consideration is the 2-PL or 2nd Party Logistics.

2-PL is where we contract with a carrier (2nd-Party) with an order to pick up the finished product from our Facility and deliver it directly to our customers. See below for an infographic describing this process.

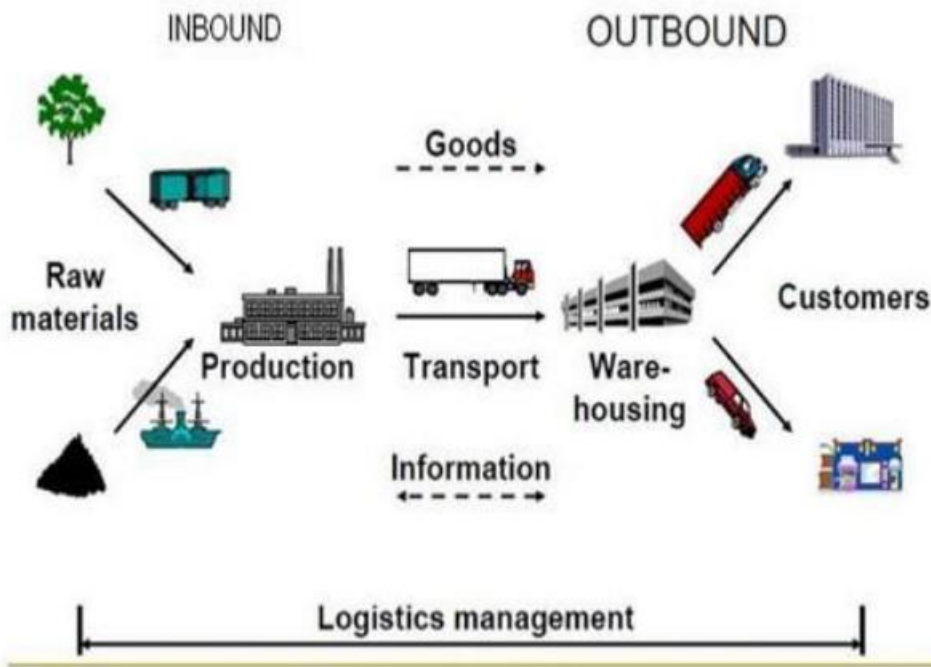

Outsourced 3rd and 4th Party Logistics (3-PL & 4-PL), The case for 3-PL and 4-PL 3rd and 4th party Logistics

To reduce the risk of long-term leases on large warehouse footprints and the extensive costs of large Pallet racking systems, 3rd and 4th Party Logistics partners should be considered.

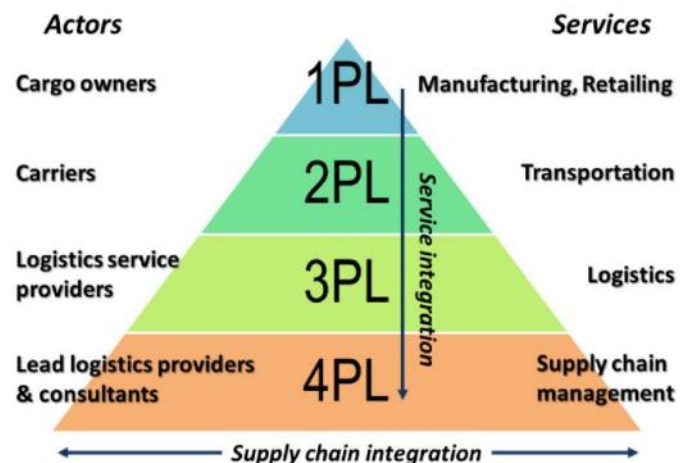
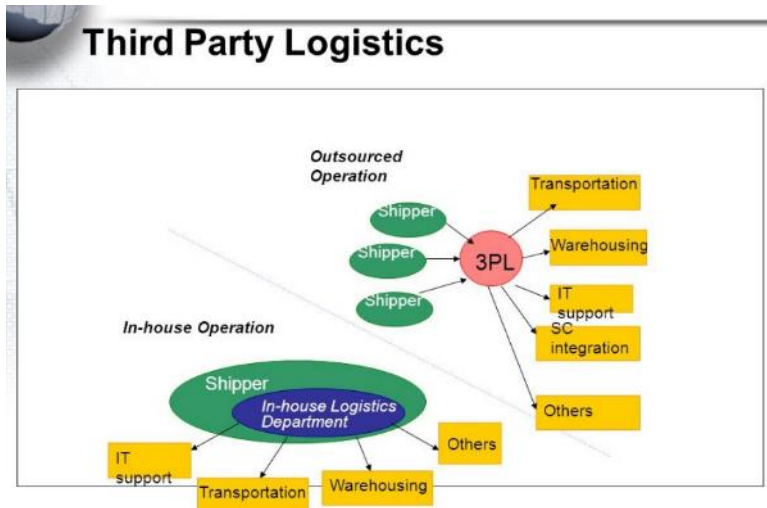

Warehouse and Logistics Management

A warehouse management system IT is a software application designed to support and optimize warehouse functionality and distribution center management.

Warehouse and Logistics Management is typically a 3rd party software system designed for inputting End-point manufacturing data, inventory control, labeling, 2nd party carriers thru receipt of the end-user.

Production Monitoring and End-point data collection

Our design requires a homogenous platform with an automation master plan that follows throughput for each work-shift and each national plant location. The Plan needs to procure a quality cloud-based system, the correct hardware, software, IT infrastructure, panels, security, instrumentation, and wiring.

Endpoint Security Strategies - Our End-point data is a high-value asset, and we have integrated cybersecurity measures to protect against ransomware and other cyber issues.

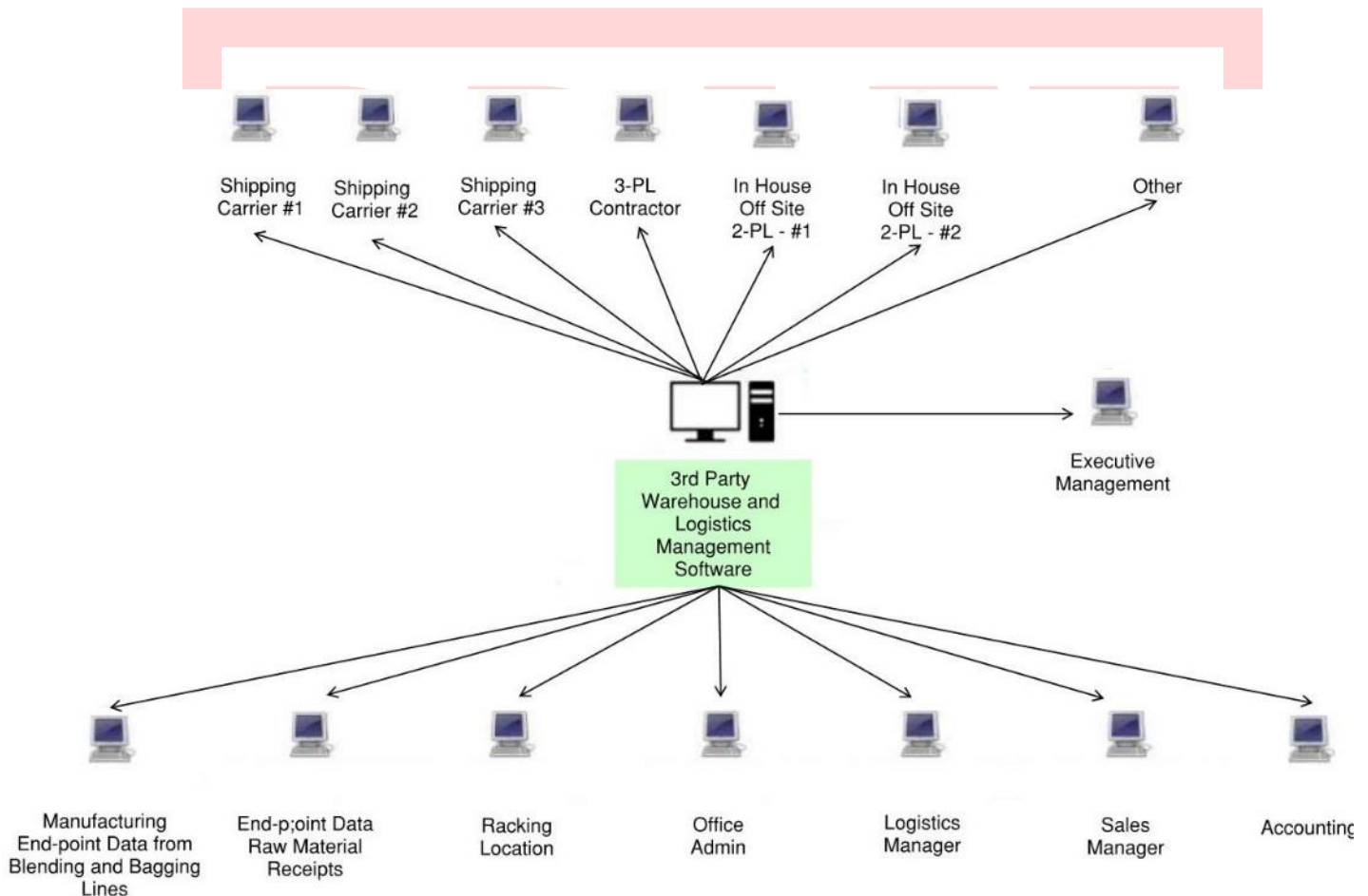

Local Security Systems

Key Card System

Our design intent is to install a basic key card access system giving us control over which employees and others can access certain areas of property and production facility. It denies individuals access to sensitive areas.

Access Control Systems

We identify locations that need to limit access to certain areas that use access control. We create control systems to provide a more secure environment. First, an employee using a key fob is identified using a door. Next, their activity reports into a network log. Lastly, the door is locked/unlocked with an electric strike without anyone else being onsite.

The system will be monitored at a remote station 24/7.

Benefits of Access Control

- Limit employee and customer access to certain areas of your business

Project Close-out

Essential Spare Parts

Essential spare parts inventory must be maintained at agreed levels at all times.

Initial spare parts Inventory levels are suggested by the manufacturer and reevaluated as our process dictates reevaluation of the spare parts inventory.

Commissioning

As part detailed commissioning plan will be bought commissioning and staff training service from each of the major equipment suppliers. The commissioning process is ongoing and evolving thru team meetings with the major equipment manufacturers, the process engineer, the controls contractor, and other key persons.

Close-out Documents

Diligent procurement and digital off-site archiving is essential to the long-term success of the project.

As-Built Drawing

Detailed As-Built Drawings will be developed as the project proceeds and final As-Builts submitted and the project conclusion

Warranty Agreements

We will continue to negotiate and evaluate the cost for the normal manufacturer's warranty vs. extended warranty plans.

DRAFT

Pallet Racking - Damaged Racking – Safety

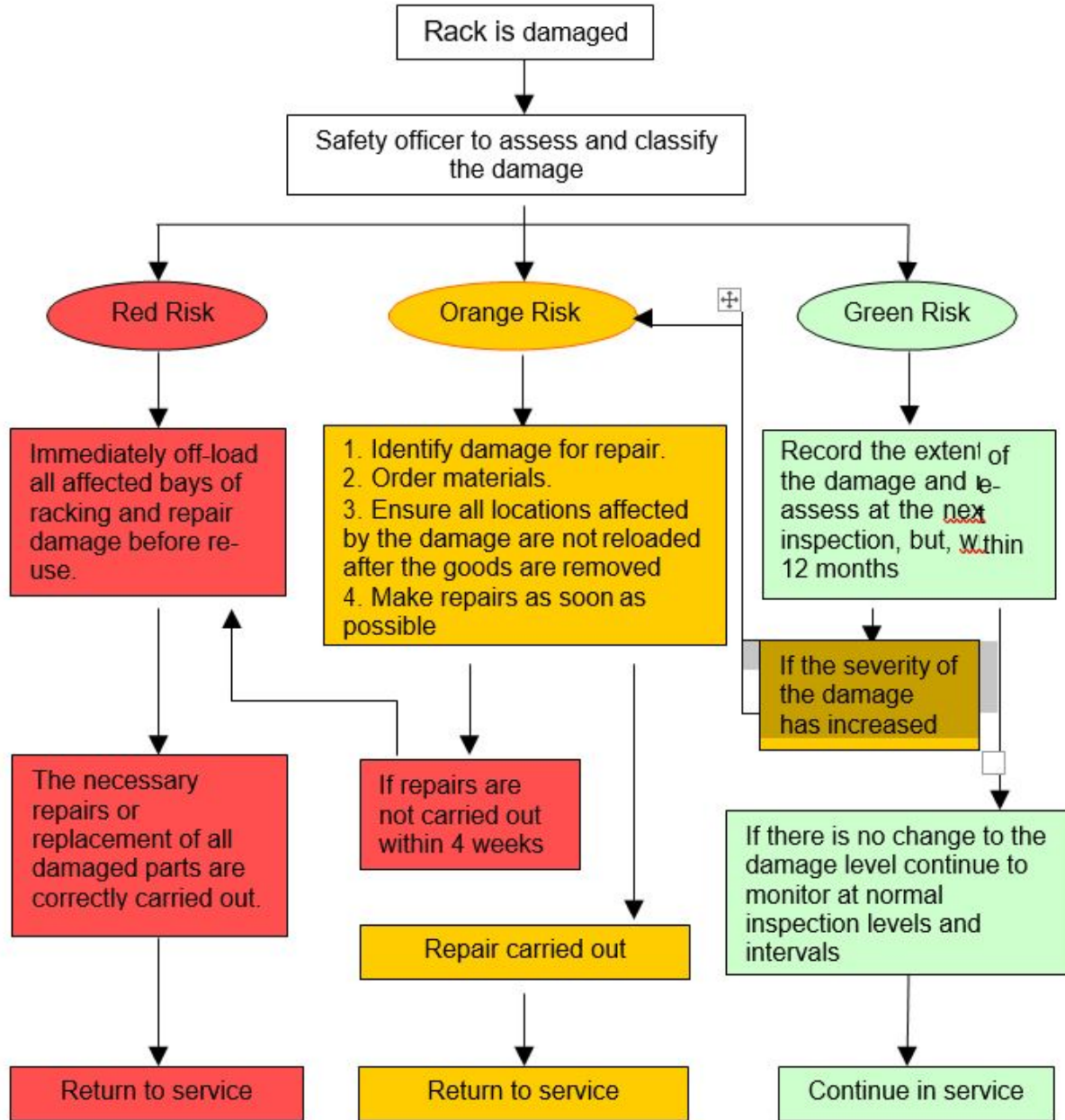

Exhibits:

A. Equipment

B. Improvements to the structure

C. Drawings – Design/Development

D. Schedule

E. Safety

DRAFT

Exhibit - A Equipment

Evaluation of Machinery considers:

1. Machinery and Equipment – Define the following inclusions
 - a. Warranty
 - i. Warranty Period
 - ii. Warranty Inclusions
 - iii. Warranty Exclusions
 - b. All piping, wiring, associated supports, connections, etc.
 - i. From panels or other utility sources on the walls of the shell building thru your equipment.
 - ii. From the Foundation / Structural slab upward thru your equipment.
 - iii. From your equipment up and thru any structure above.
 - c. Controls
 - d. Motors
 - e. Motor Controls
 - f. Motor Controls Wiring
 - g. Software – including any costs related to software sales, rental, update during Warranty period, etc.
 - h. Ladders, stairs, support structures
 - i. Delivery costs
 - i. FOB costs including any trucking, rail, air, or other costs including incidentals.
 - ii. All national and international duties, excise taxes, fuel, taxes or other related to equipment, , shipping for any and all equipment / components to project site.
 - iii. Loading at your Facility
 - iv. Unloading at our Facility
 - v. Crating, packaging, handling fees
 - j. All foreign, USA federal / state / Local taxes in any form.
2. Detailed design CAD design drawing, design data, and specifications in a format required for our design staff to place in our combined process construction / permit drawings
3. Commissioning
 - a. Describe Commissioning and time period required
 - b. Training of onsite operators and other end users
 - c. Hourly or daily cost for your representative during commissioning
 - d. Peridium costs
4. All licensing, royalties, patent fees, or similar – due your firm or any 3rd party firms during the operation of your process.
5. Are there government operating licensing, ongoing operating permitting costs specific to operating your equipment operation.
6. During the life cycle of operation what should we expect for ongoing consulting costs?
7. During the life cycle of operation what should we expect for ongoing periodic maintenance costs?



Blending Line

Sackett Waconia is providing the engineering and equipment for our Precision Horizontal Blending Systems. To meet the needs of markets that require precise blends but have low overhead space, Sackett-Waconia developed the Precision Horizontal Blending System as an excellent option

for existing warehouses. Combining our Declining Weight technology with the blend quality of our HIM Mixer or Orbital Blender yields a highly effective floor-based blending system. As with our DW Systems, precision horizontal blending systems can include additional hoppers for granular and powder micronutrients and can include bagging options upon request.



Sackett Waconia's Legacy

For over 120-years, Sackett-Waconia has been on the leading edge of the Fertilizer Industry. Since 1897, the Company has been a leader in technology and innovation. With over 200 patents, equipment on six continents and in over 60 countries, 4-manufacturing plants, and joint ventures in Brazil and South Africa, we continue to provide industry-leading technology and support in the US and worldwide.

Engineering & Design

Listening to and understanding our customers' needs is an essential operation at Sackett-Waconia. No matter the size of the project, we strive to:

- Take the time to assess every customer's needs
- Make sure we design the system that is the best fit for them
- Ensure the systems will meet their needs over a most extended service life

We understand that each business is an individual and will take the time to engineer the best solution for your needs. Our experience was built over a long history and came from the smallest retail plant and the largest hub plants.



BUDGET PROPOSAL

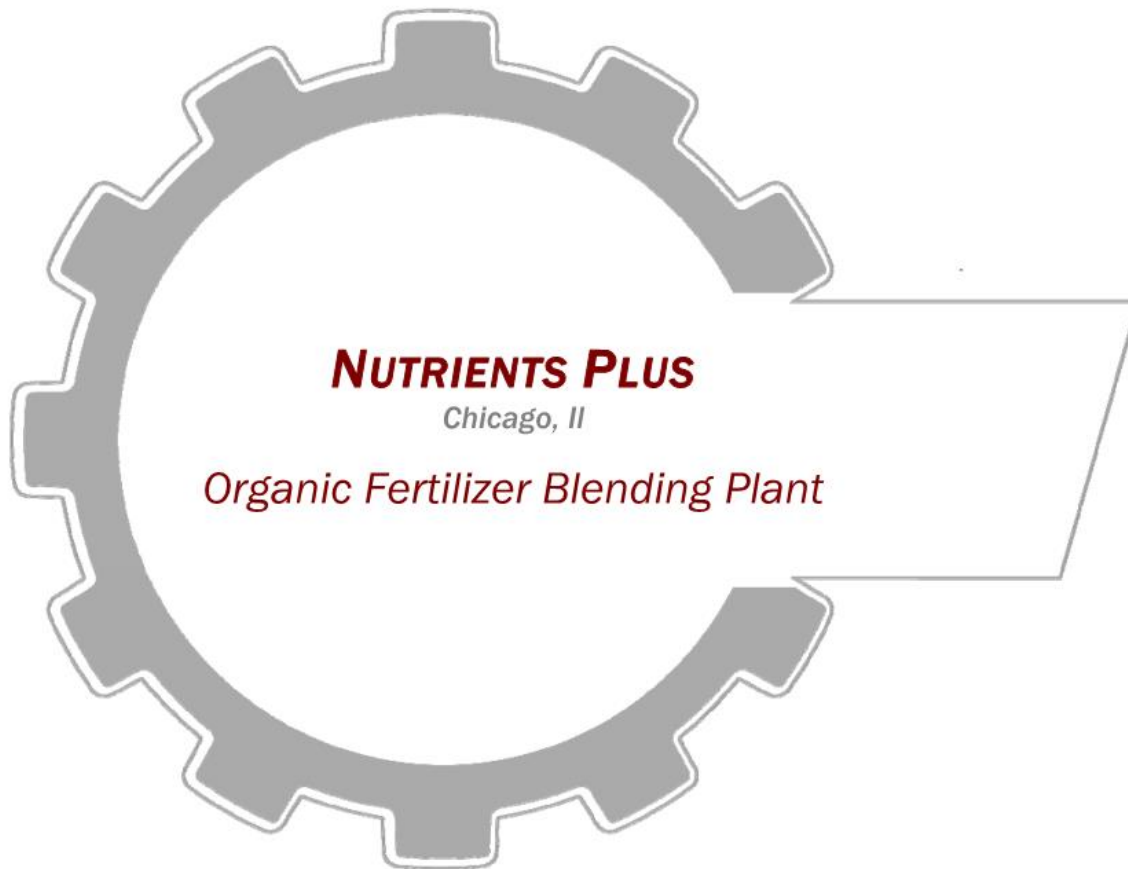

QUOTE DATE	QUOTE NUMBER	DRAWING REFERENCE	SALESPERSON
11/17/20	BP20-00195-RB	L20-00195-RB	John Lamneck/John Mitchell

1701 South Highland Avenue • Baltimore, MD 21224 • (410) 276-4466
33 East 8th Street • Waconia, MN 55387 • (952) 442-4450
680 Tacoma Boulevard • Norwood-Young America, MN 55386 • (952) 442-4450
1719 Baldree Road • Wilson, NC 27893 • (410) 276-4466

**RECEIVING AND BLENDING SYSTEM**

ALL CAPACITIES BASED ON AVERAGE 60 PCF DRY, FREE FLOWING GRANULAR NPK FERTILIZERS. HORSEPOWER CALCULATIONS BASED ON 80 PCF MATERIAL.

PART I: RECEIVING SYSTEM - APPROX 200 TPH

- A. 1 **Sackett-Waconia Model BT250, Stainless Steel Bulk-Toter Flighted Chain Conveyor**, consisting of the following:
- 33'-6" Overall Length
 - 140 Feet per minute chain speed
 - 15 HP Totally enclosed, fan cooled motor with Industrial Grade Reducer, necessary power transmission components, and stainless steel drive guard
 - Fully enclosed, type 304 stainless steel, weather resistant casing
 - Take-up Section consisting of:
 - Removable maintenance door
 - Self-aligning, stainless steel, take-up rod and carbon steel frame
 - "Flood Feed" inlet for truck, with 5'-0" x 10'-0" intake, and heavy duty drive over grate – **pit, pit design, sump, and additional coverage by others**
 - 45 Degree Curve section with large radius and stainless steel 10 gauge separator plate
 - Head section with drive base, maintenance and inspection door, and bolt-in stainless steel 10 Gauge separator plate
 - Heat-treated carbon steel 102B chain with heat-treated stainless steel pins, UHMW conveying flights, one set of steel cleaning flights, and zinc plated flight attachment hardware
 - Stainless steel stub leg supports for horizontal section, and (x) carbon steel "A" frame support stands
 - Stainless steel discharge transition
- B. 1 **Sackett-Waconia Model BE250 Stainless Steel Centrifugal Belt Type Bucket Elevator**, consisting of the following:
- 450 Feet per minute belt speed
 - 40 HP Totally enclosed, fan cooled motor with Industrial Grade Reducer, necessary power transmission components, integral backstop, and stainless steel drive guard
 - 25'-1" Discharge height
 - All casings, head, and boot sections Type 304 stainless steel
 - 10 Gauge Boot section with:
 - 30" Diameter x 18" face, self-cleaning wing type boot pulley and shaft supported by Dodge bearings
 - Grease packed, stainless steel, enclosed screw type take-ups
 - 10 Gauge boot hopper
 - 20" x 52" Type 304 stainless steel 12 Gauge casing with angle flanges



- 16" Wide rubber belt, 2ply, 220 P.I.W. rating with 1/16" x 1/16" covers and mechanical splice
- 14" x 7" style "CCHD", polyethylene buckets on 7" centers w/ stainless hrdwr
- 10 Gauge Head section with:
 - 30" Diameter x 18" face, rubber lagged, drum type head pulley and shaft supported by Dodge bearings
 - 14 Gauge Split Bonnet
- Zero speed switch
- Stainless steel discharge transition
- Ladder and safety cage - carbon steel
- Service/head platform, and (1) step off platforms - carbon steel with FRP decking

C. 1 Tripper Conveyor Tail Platform, consisting of the following:

- Carbon steel construction with bolted connections
- Access deck with handrails, kick-plate, and FRP decking
- Gate at entrance from ladder step-over
- Supports and provides access to tripper tail section
- **Platform to be supported / knee braced off of building – SW to provide interface details and equipment loadings**

D. 1 Sackett-Waconia 24" Wide, Stainless Steel Fixed Frame Tripper Belt Conveyor, consisting of the following:

- 289'-3" Long
- 350 Feet per minute belt speed
- 20 HP Totally enclosed, fan cooled motor with Industrial Grade Reducer, necessary power transmission components, integral backstop, and carbon steel drive guard
- Type 304 stainless steel formed channel frame construction with integral tripper rails
- Tail section consisting of:
 - 14" Diameter x 26" face, rubber lagged drum type tail pulley and shaft supported by Dodge bearings
 - Stainless steel, enclosed, manual screw type take-ups
 - Stainless steel feed chute with rubber skirt
 - Stainless steel pulley guard and tail cover
- CEMA "C" 5" diameter, 35 degree **HDPE** Troughing Idlers spaced on 4'-0" centers
- "Shoe type" Training Troughing Idlers
- CEMA "C" 5" diameter, Rubber Disc Return Idlers spaced on 10'-0" centers
- CEMA "C" 5" diameter, Rubber Disc Training Return Idlers
- 24" Wide rubber belt, 2 Ply, 220 P.I.W.-to be field vulcanized by others



- Head section consisting of:
 - 16" Diameter x 26" face, rubber lagged drum type head/drive pulley and shaft supported by Dodge bearings
 - Stainless steel discharge hood/pulley guard
- Safety stops, zero speed switch, and limit switches for range of motion
- Stainless steel Gravity Tripper per the following:
 - Lead-in troughing idlers, crowned drum pulley with shaft and Dodge bearings, self-cleaning wing type pulley with shaft and Dodge bearings, (4) flanged track wheels with sealed bearings, and single sided discharge spout constructed of stainless steel, with integrated belt scraper
- Stainless steel stub legs every 20'
- **Catwalk and beams to support stub legs by building contractor**

E. 1 **Electric Winch Base**, consisting of the following:

- 3 HP Totally enclosed, fan cooled motor with reducer
- Stainless steel base and guard – *mounts to conveyor frame*
- Sheave blocks, cable clamps, turn buckles
- Lot of stainless steel cable – *cable run is contained in conveyor*

F. 1 **Lot of Controls including Manual Control Panel with start/stop pushbuttons and ruin lights, and Custom MCC with motor starters and interlocks**

PART II: "ACCUBLEND" SYSTEM – APPROX 60 TPH

G. 1 **Sackett-Waconia Accublend System**, including:

6 **Major Weigh Hoppers**, consisting of the following:

- Weigh Hopper:
 - **10 Ton** Capacity – *please review inlet details vs reach of existing loader*
 - Type 304 stainless steel with flanged outlet
 - Stainless hopper support stand
 - Removable screens, FRP
 - Low level light
 - (4) IP68 Stainless steel hermetically sealed load cells with tool steel mounts, Stainless steel hardware, and junction box – NTEP certified – *hopper not to be refilled while discharging*
- Salem Valve, stainless steel, 12" square, air operated with canvas connection to take-away unit
- Stainless steel support base with bolted connections
- (1) Heated solenoid enclosure for all valve solenoids, including bypass diverter at mixer – **mounting by others**



- H. 1 **Sackett-Waconia Model BT250, Stainless Steel Bulk-Toter Flighted Chain Conveyor**, consisting of the following:
- 91'-8" +/- Overall Length
 - 180 Feet per minute chain speed
 - 40 HP Totally enclosed, fan cooled motor with Industrial Grade Reducer, necessary power transmission components, and stainless steel drive guard – **soft start starter required**
 - Fully enclosed, type 304 stainless steel, weather resistant casing
 - Take-up Section consisting of:
 - Removable maintenance door
 - Self-aligning, stainless steel, take-up rod and carbon steel frame
 - (6) Flanged "Control Feed" inlets
 - 13 Degree Curve section with large radius and stainless steel 10 gauge separator plate
 - Head section with drive base, maintenance and inspection door, and bolt-in stainless steel 10 Gauge separator plate
 - Heat-treated carbon steel 102B chain with heat-treated stainless steel pins, UHMW conveying flights, one set of steel cleaning flights, and zinc plated flight attachment hardware
 - Zero speed switch
 - Stainless steel stub leg supports for horizontal section
 - Stainless steel discharge transition
- I. 1 **Sackett-Waconia Direct Drive Orbital Blender**, consisting of the following:
- 8 Ton capacity - high quality blends, gentle handling, short blend time
 - Drum Drive – 30 HP Totally enclosed, fan cooled motor with industrial grade reducer
 - Screw Drive - 20 HP Totally enclosed, fan cooled motor with industrial grade reducer – **reversing starter required**
 - 10 Gauge type 304 stainless steel inlet and outlet
 - ¼" Stainless steel plate drum, consisting of the following:
 - Stainless steel internal mixing flights
 - (4) Inspection doors
 - (4) Heavy duty carbon steel cam rollers with mounts to support / turn drum
 - Seals to provide dust tight operation
 - 18" Feed/Discharge screw, consisting of the following:
 - Carbon steel screw flights
 - Hardened end shafts of 1045 carbon steel
 - Stainless steel screw trough
 - ¼" Stainless steel rectangular tubing frame with capped ends and mounts
 - Impregnation spray bar, stainless steel, ¾" pipe- **liquid system and piping to spray bar quoted as option below**



- J. 1 **Sackett-Waconia Model BE250 Stainless Steel Centrifugal Belt Type Bucket Elevator, consisting of the following:**
 - 465 Feet per minute belt speed
 - 25 HP Totally enclosed, fan cooled motor with Industrial Grade Reducer, necessary power transmission components, integral backstop, and stainless steel drive guard
 - 33'-0" Discharge height
 - All casings, head, and boot sections Type 304 stainless steel
 - 10 Gauge Boot section with:
 - 30" Diameter x 18" face, self-cleaning wing type boot pulley and shaft supported by Dodge bearings
 - Grease packed, stainless steel, enclosed screw type take-ups
 - 10 Gauge boot hopper
 - 20" x 52" Type 304 stainless steel 12 Gauge casing with angle iron flanges
 - 16" Wide rubber belt, 2ply, 220 P.I.W. rating with 1/16" x 1/16" covers and mechanical splice
 - 14" x 7" style "CCHD", polyethylene buckets on 8" centers with stainless steel hardware
 - 10 Gauge Head section with:
 - 30" Diameter x 18" face, rubber lagged, drum type head pulley and shaft supported by Dodge bearings
 - 14 Gauge Split Bonnet
 - Zero speed switch
 - Stainless steel discharge transition
 - Ladder and safety cage - carbon steel
 - Service/head platform, and (1) step off platform - carbon steel with FRP decking

- K. 1 **Lot of spouting to feed bagging hoppers, stainless steel**

- L. 1 **Bagging hoppers and bagging equipment by others – SW blending system will need feedback from level switches in these hoppers - options TBD**

- M. 1 **Lot of "Automated" Controls including Windows Workstation, PLC, and Custom MCC with motor starters and interlocks**

- N. 1 **Lot of Commissioning / Start Up / Training / On Site**

TOTAL BUDGET PRICE FOR ALL OF THE ABOVE \$ 840,800.00 +/- (Ex-Works, Point of manufacture)
--

***Dust collection, Bagging Equipment, Freight, and installation not included**



“BUDGET” OPTIONS -

- a. Freight budget \$ 35,000.00 +/-
- b. Critical Spares budget..... \$ 20,000.00 +/-
- c. Liquid Impregnation System \$ 9,500.00 +/- (each)
- d. Micro Hopper – fed by big bags..... \$ 17,500.00 +/- (each)
- e. Bagging hopper with structure and level switches.....\$ 22,000.00 +/- (each)

GENERAL NOTES/ PAINT SPECIFICATIONS

- 1. All carbon steel components painted with a corrosion resistant primer and machinery enamel topcoat Sackett-Waconia Blue unless otherwise specified.

ADDITIONAL ITEMS INCLUDED IN SCOPE

- Anchor Bolt Plan w/ loadings
- Complete motor list with recommended starters

RECOMMENDED/ CRITICAL SPARE PARTS

SW will prepare a “project specific” quotation on recommended/critical spare parts for start-up and/or stocking. This will be generated after approval drawings have been returned and all equipment designs have been finalized. Additionally, SW offers a 10% discount on these parts if they are ordered with the equipment. This will also save on additional freight costs that would be associated with a separate shipment.

ELECTRICAL CHARACTERISTICS

Primary Voltage - 230/460 Volts, 3 Phase, 60 Hertz
Control Voltage - 24 Volts DC

Note: Please verify voltage at time of order – if different than specified, some price adjustment will be required

INSTALLATION DRAWINGS AND MANUALS

- Included with the shipment:
 - One (1) electronic copy of the installation, operation, and maintenance manuals, with assembly drawings and bills of material.
 - One (1) paper copy of all assembly drawings, manuals, and bills of material.

ENCLOSURES

- Sackett-Waconia NOT FOR CONSTRUCTION Layout Drawing: L20-00195-RB



PAYMENT TERMS & SHIPPING

- A. The above prices are Ex-Works, point of manufacturer. Further, it does not include any Federal, State, Municipal or other Excise Taxes, Sales, Use, or Similar Taxes, which may be in effect at time of shipment.
- B. Any changes made to proposal after receipt of purchase order are subject to price and delivery adjustments.
- C. Equipment specifications and prices are subject to change with final lay-out drawing.
- D. Sackett-Waconia can offer an "on site" representative for a per diem rate (per person/per day) of \$850.00, plus any associated expenses for travel (mileage or airfare), lodging, and meals.
- E. Items **NOT** included in above:
 - a. Freight
 - b. Unloading of equipment
 - c. Sales tax or Permitting
 - i. If tax-exempt, please provide Sackett-Waconia with a tax-exempt certificate at time of proposal acceptance. If this is not obtained, customer will be billed at applicable tax rates.
 - d. Machinery installation
 - e. Support for conveyors, legs, and spouting – unless otherwise noted
 - f. High voltage wiring, starters, and start-stop controls – unless otherwise noted
 - g. Scale calibration and digital indicator (if required)
 - h. Soil exploration test
 - i. Concrete trenches, pit covers (except for grate over inlet) and concrete tower footings
 - j. Sheathing and purlins to enclose tower and door through tower to access leg.

PAYMENT SCHEDULE

- 25% Due Upon Receipt of Purchase Order
- 25% Due at 50% of quoted schedule completion
- 25% Due at 75% of quoted schedule completion
- 25% (Balance) Due 15 Days from Shipping

SCHEDULE OF DELIVERABLES – (as of the date of this Proposal)

APPROVAL DRAWINGS:

Approximately *6 weeks after receipt of signed proposal

SHIPMENT OF EQUIPMENT:

Approximately *7 – 8 +/- months after receipt of Approved Drawings

*** To be confirmed at time of order**

*** Time frames listed are typical of similar sized projects, based on today's workload. Time frame is intended to be a guide only.**



Standard Terms of Sale

RISK OF LOSS:

Title to and risk of loss for the equipment and parts shall pass to Purchaser upon shipping from Seller's facility or other shipping point; provided, however, the Purchaser grants to Seller a present and continuing security interest in the equipment and parts until Seller has been paid in full to the terms hereof. Purchaser shall promptly execute and deliver such documentation as may be requested by Seller to perfect Seller's security interest. Purchaser will not cause or permit any other security interest, lien, encumbrance or claim to attach to the equipment and parts which shall have priority over, or be ahead of, Seller's security interest, as described herein; and Purchaser authorizes Seller to make any public filings necessary to perfect or maintain its security interest.

INSTALLATION:

No installation service is included in the price quoted herein. Seller is not responsible for installing the equipment or the means and methods employed by the installer of the equipment. Purchaser has contracted with others to install the equipment. Purchaser agrees that prior to delivery of the equipment and parts, Purchaser will perform or cause to be performed all actions necessary to prepare the site for installation at its sole cost and expense.

FREIGHT:

All equipment and parts will be Ex-Works, Point of Manufacture, and Purchaser is responsible for all freight costs.

UNLOADING EQUIPMENT:

Purchaser shall bear the cost and risk of unloading all equipment delivered to Purchaser's plant site or other site.

OSHA:

Seller will endeavor to design its equipment to meet technical requirements of OSHA. However, sole authority to determine compliance rests with the Purchaser and responsibility for field changes of equipment to meet different interpretations are the users.

SAFETY:

Sackett-Waconia equipment and equipment systems are not designed to handle materials which are combustible and/or which release combustible dust during transportation. Use of such materials can cause an explosion or fire resulting in property damage, serious injury or death. If you choose to use combustible materials, consult qualified design experts to help minimize this risk.

CHANGES AND ALTERATIONS:

Changes and alterations to the equipment requested by the Purchaser after this proposal becomes a contract will require re-negotiations for possible changes in the contract price. Changes required due to improper location of adjoining equipment or building openings from improper information provided on drawings furnished to the Seller by the Purchaser for layout purposes shall be paid by the Purchaser.

DRAWINGS:

Unless otherwise specified, all drawings, illustrations or samples prepared by Seller applicable to this Agreement are to be considered as property of Seller and shall be returned on demand. These drawings or samples shall be considered as confidential and shall be used in no way which is detrimental to the best interest of Seller. Where drawings are prepared by the Seller, the Purchaser shall evidence its approval, upon request, by signing such drawings.

CANCELLATION:

Cancellation of this Agreement without liability, after acceptance by the Purchaser, can be made only with Seller agreeing in writing. In the event of cancellation or suspension of manufacture of the equipment or parts at the Purchaser's request, Seller will have available to it all remedies allowed to Seller as set forth in Article 2 of the Uniform Commercial Code.

WARRANTY:

The equipment and parts manufactured by the Seller specified herein are guaranteed for a period of one year from the date of shipping against defects in material and workmanship. If, at any time during this period, any equipment or part becomes defective and the Purchaser notifies the Seller in writing

All information within this document is property of Sackett-Waconia and is confidential. It is intended only for the addressed recipient and must not be copied or used to the disadvantage of Sackett-Waconia.



of such defect, the Seller agrees to repair or replace such equipment or part at its cost. All components not manufactured by the Seller are limited in warranty to that offered by the manufacturer. No other express warranty is given and no affirmation by the Seller or action shall constitute a warranty. Seller's warranty does not apply to equipment that requires service or replacement due to the following causes: user error, failure to properly perform required periodic maintenance, misapplication, misuse, casualty loss, abuse, vandalism, alteration, unauthorized attachment or modification, unauthorized repair, or other similar causes.

THE WARRANTY STATED ABOVE IS IN LIEU OF ALL OTHER WARRANTIES EXPRESS OR IMPLIED, AND SELLER SPECIFICALLY DISCLAIMS ALL OTHER SUCH EXPRESS OR IMPLIED WARRANTIES INCLUDING, BUT NOT LIMITED TO, THE IMPLIED WARRANTIES OF MERCHANTABILITY AND FITNESS FOR A PARTICULAR PURPOSE. SELLER SHALL NOT BE LIABLE TO PURCHASER OR ITS AFFILIATES FOR ANY DAMAGES IN CONNECTION WITH THE SALE OF THE EQUIPMENT AND PARTS OR THE PERFORMANCE OF OTHER SERVICES HEREUNDER, WHETHER ARISING IN CONTRACT, TORT, STRICT LIABILITY OR OTHERWISE, IN EXCESS OF THE PURCHASE PRICE FOR THE EQUIPMENT AND PARTS AND ANY FEES PAID FOR SUCH SERVICES.

LIABILITY:

Anything in this Agreement to the contrary notwithstanding, it is agreed between Purchaser and Seller that, whether by breach or warranty, or otherwise, Seller's liability is exclusively limited to the repair or replacing, at its option, of defective or non-conforming equipment or parts thereof. In no event shall the Seller be liable to the Purchaser for any incidental or consequential damages.

ELECTRICAL WIRING AND PIPING:

Electrical wiring, conduit and necessary cutoff switches from the Purchaser's building circuits to the equipment purchased are not a portion of this Agreement and are to be provided by others at no cost to Seller.

TAXES, DUTIES AND PERMITS:

Sales tax, use, excise, occupational tax or any other federal, state or municipal tax, duty or permit fees have not been included in this Agreement; and the Purchaser hereby assumes and agrees to pay for any of the above taxes, assessments or fees arising out of this transaction. Seller and all of its subcontractors will sign all documents reasonably required by Purchaser in connection with Purchaser applying for and receiving sales/use tax refunds related to the equipment and parts subject to this Agreement.

CONTRACT:

This Agreement shall become effective as a contract when accepted by the Purchaser and shall not thereafter be modified except in writing similarly executed and approved. All terms of this Agreement are deemed to be fully set forth herein and no agent, sales representative or other party is authorized to bind the Seller by agreement or warranty not herein expressed.

INTEREST:

All sums hereunder not paid when due shall accrue interest from the due date until the date paid at the highest legal rate permitted by Minnesota law.

INSURANCE:

Seller does not include insurance coverage for materials or machinery purchased from others and shipped to Seller's plant for installation or assembly.

CHOICE OF LAW/ SEVERABILITY:

This Agreement has been made and its validity, performance and effect shall be determined in accordance with the laws of the State of Minnesota, choice of law provisions notwithstanding. If any provision of this Agreement is invalid or unenforceable under applicable law, the provision shall be ineffective only to the extent of such invalidity or un-enforceability without in any way affecting the remaining parts of the provision or of this Agreement.

FORCE MAJEURE:

Neither party shall be liable to the other or deemed to be in breach of this Agreement by reason of any delay or omission solely due to fire, flood, or other act of God, labor or transportation strike or stoppage, act of war, precedent or priority granted at the request of, or for the direct or indirect

All information within this document is property of Sackett-Waconia and is confidential. It is intended only for the addressed recipient and must not be copied or used to the disadvantage of Sackett-Waconia.



benefit of any governmental authority, import or export restriction, or other like action, event or condition; provided, however, that prompt notice of the delay or omission and its cause shall be given to the other party. If, however, force majeure circumstances which the Seller could not foresee in the determination of completion dates, result in the delay of delivery or performance, Seller is obliged to notify Purchaser's project manager of this fact in writing without delay. If the Seller fails to comply with this obligation, it cannot invoke the force majeure circumstances as an excuse for delay in delivery or performance. Upon receipt of such notice, the dates for performance shall be postponed to the extent required to take account of the effects of the matter causing the delay on a case-by-case basis to be agreed between Purchaser and Seller.

VENUE AND WAIVER OF TRIAL BY JURY:

The parties agree that the proper venue for any litigation to resolve any dispute regarding this Agreement shall be in the United States District Court for the District of Minnesota, or any state District Court of proper jurisdiction in the State of Minnesota. The parties hereby expressly waive any right to trial by jury in any litigation between the parties regarding this Agreement and agree that all legal and factual questions involved in any dispute litigated between the parties shall be submitted to the Judge of the Court in which the case is filed for determination

AMENDMENT:

This Agreement may only be modified or amended by written documents signed by authorized officers or representatives of Seller and Purchaser.

ENTIRE AGREEMENT:

This Agreement represents the entire and integrated agreement between Seller and Purchaser and supersedes all prior negotiations, offers, counteroffers, representations or agreements, either written or oral.

EXECUTION:

Signing this document by both Purchaser and Seller constitutes a binding contract enforceable in accordance with its terms.





BUDGET PROPOSAL SIGNATURE

This budget proposal has been offered by the A.J. Sackett & Sons Company and Waconia MFG, Inc. on this 17th day of November 2020.

A handwritten signature in black ink, appearing to read "John Mitchell".

John Mitchell, Manager, Inside Sales and Application Engineering
Sackett-Waconia Authorized Signature

JMM: mak



ZONE	REV	DESCRIPTION	DATE	MADE BY
B	1	GEN. LAYOUT REVISION	11/14/20	MK

REVISIONS	DESCRIPTION	DATE	MADE BY

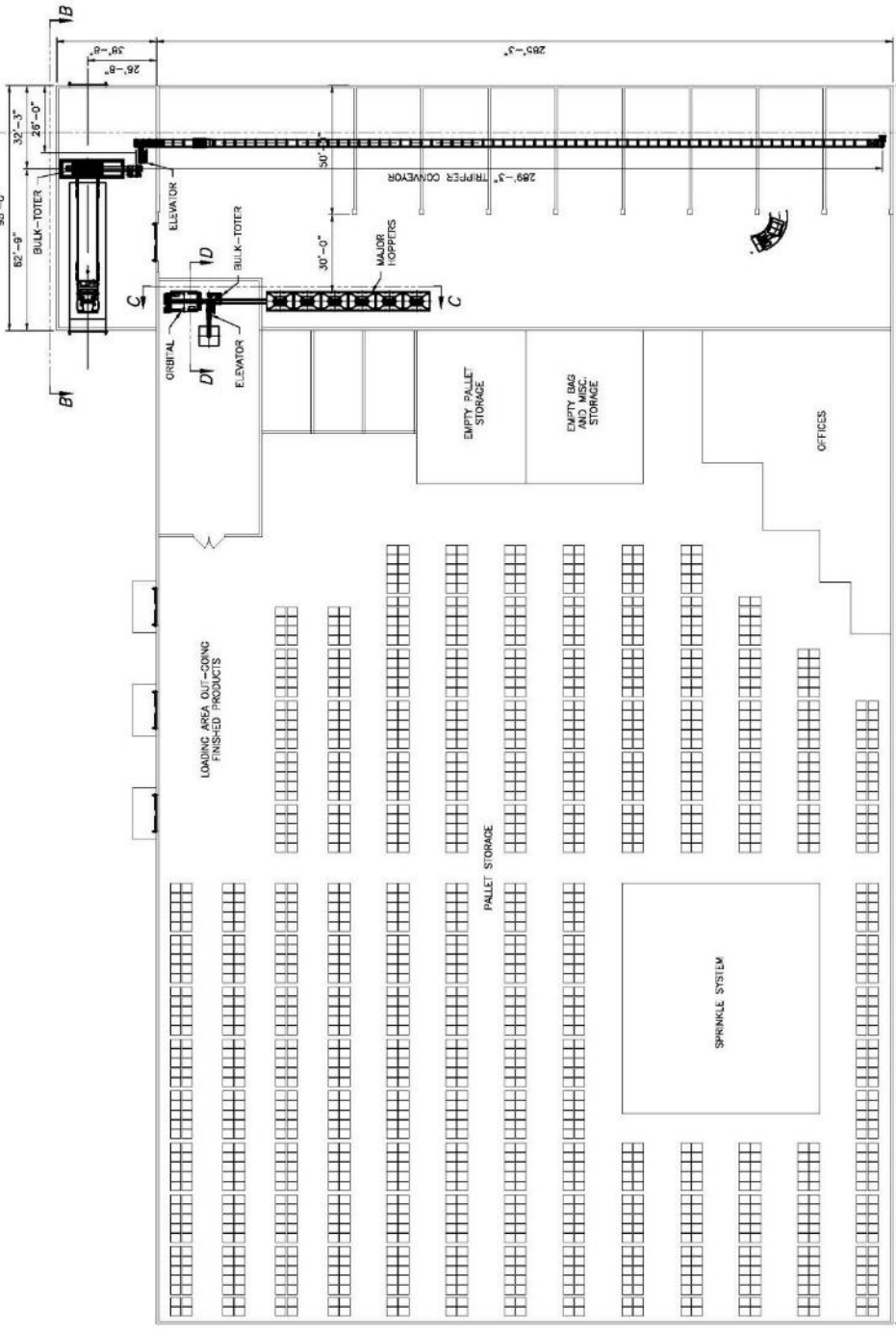

SACKETT-WACONIA
 1701 S. HIGHLAND AVE.
 WACONIA, MN 55157
 (763) 771-1100

20-00193
 GRANULE FERTILIZER
 BLENDING PLANT
 INTRIGETS PUE
 CIGAND, E.
 20-00195
 1 OF 2
 MK
 8/14/20
 2/14/20

CONFIDENTIAL
 THIS DRAWING AND ALL THE INFORMATION THEREON IS PROPERTY OF A.J. SACKETT, IS CONFIDENTIAL AND MUST NOT BE COPIED OR REPRODUCED IN ANY MANNER WITHOUT THE WRITTEN PERMISSION OF A.J. SACKETT, AND IS SUBJECT TO RETURN UPON DEMAND.

PLAN VIEW

1 2 3 4

Bagging/Palletizing/Shrink-wrap Line

Two Companies with Similar Beginnings

In the early 1900s, two packaging companies emerged in the Minneapolis packaging supplier industry - Hamer and Fischbein. Both companies developed their solutions to closing industrial product bags that were prevalent during this time. Some of these products include flour, potatoes, and packaged ice. In these early years, Fischbein developed and perfected its bag sewing technology and Hamer its practical Ring bag closer.

One hundred years later, brought together under the Duravant family of operating companies, the two businesses merged to form one dynamic Company - Hamer-Fischbein. This new dynamic Company offers a full line of bag filling, closing, automated bagging, and palletizing equipment targeted at industrial bagging customers.

Hamer-Fischbein Plymouth Plant

Hamer-Fischbein Today

Hamer-Fischbein designs and manufactures bagging equipment and packaging solutions under the Hamer and Fischbein brands. These trusted brands combine almost 200 years of industrial bag closing and automated packaging experience with improving packaging line efficiency and profitability.

Hamer-Fischbein is the worldwide leader in Bagging Automation, Bag Filling, Bag Top Closing equipment, and turnkey bagging automation systems. The portfolio includes the most comprehensive product range of weighing, filling, and bag closing technologies; manual, semi-, and fully automatic bagging systems; form fill seal bagging automation; conveyors; and robotic bag palletizers. Hamer-Fischbein serves diverse end markets, including agriculture, animal feed, seed, pet food, chemical, mineral, milling, food, building material, medical and pharmaceutical, lawn & garden, and packaged ice with sales service in over 160 countries. The Company operates manufacturing facilities in Plymouth, MN, and Statesville. Our mission is to consistently deliver unrivaled

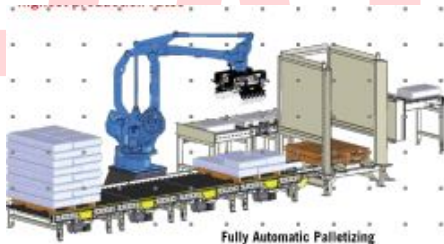

performance to our customers and partners through leading product design, project delivery, and exemplary technical service.

Bart Lynam

From: Paul Solberg <paul.solberg@hamer-fischbein.com >
Sent: Friday, November 13, 2020 1:22 PM
To: Bart Lynam
Subject: RE: Hamer-Fischbein - Chicago Blending and Bagging Facility
Attachments: 20_11_6098 Nutrients Plus - Chicago, IL.pdf; Plant Setup 15.pdf; Model 600NW-200NW-brochure-9-16.pdf; Model 2090 4.19.pdf; HF-Palletizer_broch-8.19.pdf; Wulftec WCRT-200.pdf

Hi Bart,

Thank you again for the time you spent with me on the phone helping me understand your business and future packaging needs. I've attached a budgetary quote and spec drawing for an automated packaging system for your product in poly bags. After reviewing please let me know what questions/concerns I can address for you.

We discussed the possibility of purchasing two line...if you were to purchase 2 lines the single stretch wrapping system would be able to handle full pallets from both lines so a second wrapper would not need to be added. We would also be able to offer a 2% discount on the purchase of 2 systems at the same time.

Model 2090 Video Link: <https://vimeo.com/258316319>
Robotic Palletizing Video Link: <https://vimeo.com/240899426>

Regards,

Paul Solberg
Regional Sales Manager – Great Lakes



HAMER-FISCHBEIN
14650 28th Avenue North
Plymouth, MN 55447
Direct 763.277.8705
Mobile 612.799.0053
Fax 763.231.0101
paul.solberg@hamer-fischbein.com

Confidentiality Note: This e-mail message and all attachments to it are intended only for the named recipients and may contain information that is privileged, confidential, or otherwise protected from disclosure. If you are not one of the intended recipients, please do not duplicate or forward this email message and immediately delete it from your computer.

From: Bart Lynam <b.lynam@midwaventerprises.com>
Sent: Tuesday, November 10, 2020 3:55 PM
To: Buffy Hagerman <Buffy.Hagerman@hamer-fischbein.com>

Cc: John Moriarty (jmoriarty@claruschoice.com) <jmoriarty@claruschoice.com>; Bart T Lynam <btlynam@comcast.net>

Subject: Hamer-Fischbein - Chicago Blending and Bagging Facility

Buffy,

1. We are looking for a fully automated bagging, palletizing, and shrink-wrap line
2. See the attached worksheet - the team is reviewing, and I will send you any corrections.
3. I also attached our conceptual floor plan for the facility.
4. See the attached area map for our prospective property location

We will price 1-line and a 2nd as an alternate (hopefully, our budget will allow for 1-lines.)
Are there any savings when we purchase 2-lines?

Regards,

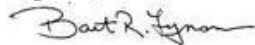

Bart R. Lynam



Phone: 630-841-7755

Email: bart@lynam.com

Web page: <https://www.lynam.com/>

 www.linkedin.com/in/bart-lynam

Disclaimer

The information contained in this communication from the sender is confidential. It is intended solely for use by the recipient and others authorized to receive it. If you are not the recipient, you are hereby notified that any disclosure, copying, distribution or taking action in relation of the contents of this information is strictly prohibited and may be unlawful.

This email has been scanned for viruses and malware, and may have been automatically archived by **Mimecast Ltd**, an innovator in Software as a Service (SaaS) for business. Providing a **safer** and **more useful** place for your human generated data. Specializing in; Security, archiving and compliance. To find out more [Click Here](#).

November 13, 2020

Quote # 20_11_6098

Mr. Bart Lynam
Nutrients Plus
Chicago, IL

PH: 630-841-7755
Email: bart@lynam.com

Budgetary Quotation for Automatic Bagging and Robotic Palletizing System

Project Description: The proposed system is designed for bagging and palletizing of free flowing NPK fertilizers. The automatic bagging system includes bulk hopper/scale support structure, net weigh scale and form/fill/seal machine. Filled and sealed bags will be conveyed to the robotic palletizing system for stacking. The robotic palletizing system a pallet & slip sheet dispenser. After stacking full pallets will be automatically transferred to a Wulftec automatic stretch wrapping system.

The proposed system is designed to operate at 12-14 BPM and has the capacity to stage 3 finished/wrapped pallets while a 4th is being wrapped. System speeds and finished pallet staging capacity can be increased if desired, please advise and I will provide a revised proposal.

Hamer proprietary Easy Pic™ operator HMI software simplifies operation of your robot palletizer and makes operator training quick and easy. With Easy Pic™ your operator uses a simple touch screen to adjust pallet patterns, or create new patterns. No more working with complex robot control pendants and hours of training for every operator.

All Hamer Robot Palletizers are assembled and pre-wired with conduit/j-boxes prior to testing at Hamer's manufacturing facility in Plymouth, MN. Equipment is disassembled for shipment and easily assembled at your production facility.

Specifications and Unit Pricing

Bag Size (Full):	Customer to Provide
Bag Weight:	35# and 50#
Pallet Pattern (s):	Customer to Provide
Number of Layers:	Customer to Provide
Max Pallet Height:	Customer to Provide
Max Pallet Weight:	Customer to Provide
Pallet Type:	Standard 40x48
Bag Rate:	12-14 BPM Pallet Height/configuration dependent
Electrical:	460V, 3 PH, 60 Hz
Air:	Clean/Dry Air Required
Pass Height:	Automated systems use a standard 18" CDLR Top of Roller pass height.
CDLR Speeds:	All Automated systems CDLR conveyors operate At 60 FPM standard speed.
Environment	40F to 104F Non-condensing Humidity

Customer Note on Bag and Pallet information: It is important Hamer receive above bag and pallet information as early in the design and project development process as possible. Palletizing systems are designed to support the specifics of your application.

Receiving bag and pallet information late in the design or purchase process may impact system footprint and cost. We try our best to ensure our customers get accurate and detailed pricing on all projects as early as possible. Late arrival of bag/pallet information could impact your system pricing.

1) Heavy Duty Scale Support Structure w/100 cu ft Surge Hopper

Gravity Feed DUPLEX:

Used with gravity feed, servo gravity feed or gravity/vibratory feed scales only. Structural Steel scale support structure incorporating a 100 cubic foot capacity product hopper, ladder and mezzanine for ease of scale access. Hopper unit consists of three (3) Sections. Upper section is the product hopper, center section supports the weighing system and access platform, lower section consists of 4 legs separately mounted to center section. Steel I Beam Construction. Designed to OSHA safety requirements

Base Price Scale Support, Duplex	\$ 27,950.00
---	---------------------

Options:

304 Stainless 100 cu ft Steel Hopper (Hopper only, supports mild steel)	\$ 7,970.00
---	-------------

Capacitance Level Sensor 1 1/4" NPT hopper fitting, stainless steel, 115 VAC, 1 each for high/low (2 total).	\$ 1,275.00
---	-------------

Scale Support	\$ 37,195.00
----------------------	---------------------

2) Hamer Model 600NW+ SS -GG

Stainless Steel, High Speed Net Weight Dosing System, Gravity Feed, Simplex:

Enhanced High Speed, High Accuracy net weigh scale. Simplex rates of 30 BPM on free-flowing products with consistent repeatability and fill accuracy. Heavy duty simplex net weigh bagging scale with gravity gate feeders. Assembly is constructed of 304 stainless steel for corrosion resistance. Main scale assembly is built from 2 x 2 tubular 304 stainless steel. Weigh hopper is heavy gage and air operated double doors are re-enforced 304 stainless steel, direct mount load cell increases accuracy and speed, digital readout operator station using Rice Lake 920i digital weight indicator.

- Accuracy: Up to +/- 0.5 oz @ 2 Sigma
- Speed 30 BPM (material flow dependent)
- Weight range approx. 10 lb. to 110 lb. (5 kg. to 50 kg.)
- Dual load cell design maximizes signal strength and stabilization for increased accuracy and weightment speed
- Rugged weigh hopper doors increase operational life
- 4" Dust collection port
- Steep weigh hopper doors ensure fast product discharge, no residue
- Fully enclosed casing with easily detachable side panels for easy access
- Extra Fine Product Seal
- Programmable scale control displays scale weights, target tolerances,

surge bin fill status

- Controller stores up to 100 pre-set formulas
- NEMA 4X 304SS controller enclosure
- RS-232/485 Communications output to printers, other devices
- Controller is UL, CUL, OIML and NTEP approved

Electrical Requirements: 110 VAC 60Hz single phase 5 amp
Air Requirements: 10 CFM@ 80 PSI Clean/Dry Air

Base Price Model 600 NW+SS, Simplex \$ 33,450.00

Application Requirements:

304 SS Simplex Collating Chute \$ 1,320.00
Std. 38" Long or 12, 14, 16, 20, 24, and 29" Lengths

304SS Hermetically Sealed Load Cell Upgrade (Simplex) \$ 1,275.00
Replaces standard aluminum load cells.

600NW+ Servo-Control Gravity Scale Upgrade (Simplex) \$ 9,200.00
Complete servo control of gravity gate. Servo setup and operation from scale
Instrument Electrical: 230V, 1 Phase, 60 Hz

Model 600 NW+ SS Total \$ 45,245.00

3) Model 2090 Heavy Duty Form, Fill and Seal Packaging Machine

The Model 2090 automated bagging machine combines decades of innovation into a single high powered industrial packaging machine. It features a 4" structural steel frame, structural steel zinc dichromate plated sub assemblies, 4" plated hardened steel pulleys with sealed bearings, B series belts, and SEW Euro-drive motors. Variable speed AC motor on hot air sealer allows for smoother bag start/stop and easy matching of timing to bag conveyors. Hot air sealer features an automatic pneumatic separator control that separates the two sides of the sealer when a bag is not present, reducing heat sealer belt, bearing and pulley wear.

The Model 2090 frame is powder coated to withstand corrosives. All operational components are top mounted. The industrial hot knife assembly has a steel backing plate for stability as it cuts a bag side and welds seams simultaneously. Teflon knife backing keeps bag seams clean. All adjustment controls are scaled for easy, trouble free bag size changes. The 2090 forms a bag from a preprinted roll of centerfold low density polyethylene film, 2 mil to 8 mil and sizes from 10 3/4" to 26" wide, and lengths up to 42" long. After forming and filling the bag is sealed with an integral hot air sealer. Machine will support 2 vertical roll holders in various locations on frame. Bag rates up to 34 BPM.

Air removal is supported by a pneumatically actuated bag perforator providing up to twelve holes (vertically) along the side edge of the bag. Perforators are mounted to the hot knife feature, improving perforation performance and reducing wear parts in the perforator assembly. Individual hole perforators are removable and range in size from pin hole up to 7/16" diameter in increments of 1/32". Perforations facilitate air removal for effective bag palletizing.

2090 Standard Features include:

- 24VDC solid state controls
- Simplified operator touch panel
- Bag counting, Operational alarms & diagnostics
- Wire Mesh Safety Enclosure with door interlocks
- UL Listed NEMA 12 control panels
- Hand held remote operator control
- SEW Euro-drive motors
- Five color spectrum photo eye with learn
- Top frame mounted internal components
- Automatic bag top heat sealer with auto-open
- 304 Stainless steel product contact points
- Single cylinder jaw assembly w/easy change features
- Proprietary heavy duty hardened self cleaning dual sealed pulleys
- Pre-Fill, Post-Fill bag staging for added seal integrity
- Variable speed AC motors on heat sealer
- Double heat seal with knurl for seal integrity
- 20" Integrated bag top seal cooling plenum
- Heavy duty powder coated 4" structural steel frame
- Zinc Dichromate plated internal components

Electrical: (1) 230V, 3 phase 60Hz, 60 amp

Air: (1) 45 cfm @ 80 psi. ¾" line minimum - Clean/Dry Air, Note some options increase air req

Model 2090 Base Price	\$ 107,550.00
------------------------------	----------------------

Application Requirements:

MaxFill™ Product in feed Chute – Scale:	\$ 810.00
--	------------------

304 stainless steel product chute connects net weigh scales to FFS machine
 Maxfill™ provides up to 30% greater chute volume for faster bag filling

Additional Fill Opening Assembly	\$ 725.00
---	------------------

Jaw components required to support additional fill openings/chute sizes. 1 assembly required with each additional chute size.

JamControl™ Bag Jam Sensor	\$ 400.00
Photo eye and lever control for hot air sealer. Automatically opens hot air sealer when a “too full” bag is presented, eliminating bag jams. Bag drops from sealer for easy cleaning.	
Bag Top Seal Air Scrubber:	\$ 925.00
De-duster removes dust from top seal area prior to sealing. Ensures bag top seal integrity	
Jaw Spares Kit:	\$ 475.00
Additional jaw liners for jaw assembly (wear part). Set of 5 Selected to match your jaw/chute sizes at order.	
Spare Parts Kit:	\$ 1,990.00
Preventative maintenance parts kit simplifies routine maintenance. Includes film feed belts, heat element, pulleys, Teflon cloth and seal pad rubber.	
Vertical Film Lift Device:	\$ 995.00
Core chuck for use with swing arm or overhead crane. Improves film handling and speeds film change times.	
460 Volt, 3 Phase Power, NEMA 4X Stainless Steel	\$ 2,950.00
Includes a 10KVA step down transformer, wiring and mounting to HFFS Frame. NEMA 4X 304 SS enclosure for corrosive environments	
Fill Conveyor Bag Guides	\$ 600.00
Used with fine or high bulk density products to ensure bag remains properly positioned as it transfers through the FFS machine	
NEMA 4X Corrosion Resistant Control Panel with Junction Boxes:	\$ 6,150.00
NEMA 4X 304 Stainless steel control panel/enclosure provides the maximum in corrosion protection for high corrosives applications.	
FFS Corrosion Protection Package:	\$ 9,700.00
Painted conveyor beds and heat sealer, 304 stainless steel hardware, machine adjustments, lift chains, fill opening racking, and other critical adjustment components	
Model 2090 Total	\$ 133,270.00

4) Model 4200-36 Knockdown/turning conveyor:

8' long, 36" wide conveyor, 120 # high slip smooth top belt. 10 gage formed mild steel conveyor frame. Crowned take up and drive pulleys. Adjustable knockdown bar has UHMW paddle, positioned at the conveyor entrance where the bag is pushed over. Adjustable position turning wheel rotates the bag butt first. Wheel rotates or can be locked down. Stainless steel bag guides for high slip for bag positioning. Quick adjust handles for wheel. Leg stands provided. 1 HP, 3 Ph TEFC motor. 105 FPM
Electrical: 230/460 VAC, 3 PH, 60 Hz

Model 4200 Conveyor- 8 ft	\$ 8,375.00
----------------------------------	--------------------

Application Requirements:

Manual Height Adjustment - single (one side)	\$ 1,950.00
--	-------------

Bag Tracking Photoeye Photoeye, mounting, cabling, logic for tracking bags on automated systems	\$ 875.00
--	-----------

Model 4200-36 total	\$ 11,200.00
----------------------------	---------------------

5) 8' Belt Over Square Roller Conditioning conveyor: **\$ 12,300.00**

8' long 24" wide heavy-duty belt over square roller style conveyor. 12" x 7 ga steel side frame, 2.5" x 2.5" Square 7ga chain driven steel bed rollers on 12" centers 4" drive/tail pulley, 1.9" return rollers. 100 FPM belt speed. 3/4 HP TEFC motor includes bag guides. Powder coated.

6) 3' Pacing Conveyor: (qty. 2) **\$ 11,700.00**

36" long 24" wide heavy-duty slide belt with V-belt tracking conveyor. 10 gage 6" formed channel side frame, 120 FPM belt speed. 3/4 HP TEFC motor includes bag guides. Powder coated. \$5,850.00 ea.

7) 3' Picking Conveyor: **\$ 6,200.00**

36" with cut outs to allow the end effector to pick the bags up from underneath. 24" roller conveyor 1.9" rollers with urethane sleeves for positive bag grip on 3" centers, 10 gage 6" formed channel side frame. 3/4 HP TEFC motor. Chain driven. Includes fixed bag stop. Powder coated.

8) Hamer Model RPM Robot Palletizing Cell- Heavy Capacity:

Yaskawa MPL 160 II Palletizing Robot Arm - 4 Axis - 160KG (352 lb) payload. Exclusive internally routed air lines and wiring between base of robot and end of arm too. Hollow wrist provides wide range of wrist motion and maximum cable life. Supports up to 4 in-feed lines and multiple pallet build locations.

System Includes:

MPL 160II, 4 axis servo driven, 160KG robot arm:

200 lb available lift capacity (100 lb tool capacity)

Robot Mounting Base Plate/Riser:

Heavy duty steel base-plate designed to bolt to the customer's floor (at least 8 inch thick concrete required). Robot riser constructed to meet specific requirements of each palletizing system. Heavy duty steel construction. Std. 18" riser included in base system.

Primary Servo Cooling Fan:

Robot Teach Pendant:

Windows[®] CE programming pendant with touch screen and USB interface

Hamer Heavy Duty Industrial End of Arm Tool:

50 FX End of arm tooling for bag palletizing. Stainless steel gripper fingers 5/8 inch diameter, high flow pneumatic valves. Fixed bag width end effector is standard. 110 lb payload. Used on bags 6.7" to 19.6" wide, 2" to 5.5" thick. Other options available.

DX200 Robot Controller:

Yaskawa standard operational pendant used for entering of panel parameters as well as starting and stopping of the program. Includes:

- Extensive I/O suite includes integral PLC
- Supports all major fieldbus networks including: EtherNet/IP, DeviceNet, Profibus-DP and others
- Compliant to ANSI/RA 15.06-1999 and other relevant ISO safety standards.
- 7 Meter Robot Master Control Cable

Temperature range: 40 F to 110 F, 90% humidity, non-condensing

Electrical: 480 VAC, 3 PH, 60Hz, 20 FLA

Air: 2 CFM @ 80 PSI

RPM Heavy Capacity Robotic Palletizing Arm: \$ 127,250.00

Robot Application Configurations:

Ethernet Connectivity for remote troubleshooting: \$ 1,250.00
Requires customer connection at plant site

Yaskawa DX200 Chiller for High Temperature Installations \$ 7,950.00
Mounts to DX200 controller door, 2080 BTU integrated air cooling system for servo control boards, robot system controls

50 AG Easy Bag Width Adjust Adder \$ 2,300.00
Includes mechanical handle/screw bag width adjustment with bellows/covers for improved operation in dirty plant environments. 6.7" to 19.6" adjustment

42" Robot Mounting Riser Adder \$ 2,050.00

RPM Robotic Palletizing Arm w/Options: \$ 140,800.00

9) Corrosive Environment Package: \$ 16,100.00
Robot Arm Robot suit NEMA 4X Stainless Steel Control Panel/J-Boxes

10) Fully Automatic Palletizing System Enhanced Control Package: \$ 21,650.00
Sensors, I/O, Motor Starters, Allen Bradley PLC, includes controls for Pallet dispenser, slip sheet dispenser and full pallet transfer CDLR conveyors. Operator touch screen for multiple pallet stack selection, controls for pallet/slip sheet dispenser and full pallet conveyors. Includes Hamer proprietary EasyPic™ Operator HMI. Hamer proprietary AB software package allows touchscreen programming of pallet stack changes and new pallet stack configurations via intuitive operator control simplifies programming and eliminates need to learn Robot specific control software. 4-6 pallet configurations standard. Additional configuration available at additional cost. Ethernet IP hardware included.

11) Fully Automated Robot Cell Safety Guarding: \$ 12,700.00
Safety guarding consists of wire-mesh safety fence with single operator access door with safety interlocks for robot shut down when opened. Safety light curtain at full pallet exit.

12) Automatic Pallet Dispenser with Pallet Magazine: \$ 27,000.00
4" structural steel tube frame with heavy duty ¼" structural steel cross members. Individually adjusted ¼" structural steel side guides support a range of pallet

sizes and assist managing pallet stack as they discharge, Pneumatically controlled pallet capture positively grips side of pallet. 1.5 HP lift drive, photo eyes for pallet status, fork truck loaded, capacity for up to 15 pallets. 4 way and 2 way pallets and CHEP pallets. Supports sizes from 30" X 30" to 48" x 48"

13) 13' Empty Pallet Transfer Conveyor: \$ 8,300.00

13'0" long, 52" wide 4 x 5.4 steel channel supports, 2 ½ x 11 ga
Rollers on 6" centers, 5" Steel Channel supports, ½ HP motor, powder
Coated. 18" TOC load height. 30 FPM

14) Automatic Slip-sheet Dispenser: \$ 15,000.00

Dispenser capacity of a 30" stack of slip-sheets with a low slip-sheet
level indicator; limit switches and valves mounted for easy maintenance.
¼" tube steel construction. Motor controlled pick/place arm uses timing
belt slip sheet placement. A low maintenance, high reliability solution

**15) 5' CDLR Full Pallet Transfer Conveyor with Pallet Squaring
Device and Pallet Stops** \$ 8,500.00

3000 lb capacity CDLR, 52" effective width, 11 gauge 2.5" rollers on 4 1/16"
centers, C6 x 8.2# drive channel, C5 x 5.4# idler channel and inclusive
of motor and gear reducer. 60 FPM. Pallet squaring device using pneumatic blade
stops and adjustable mechanical pallet guide. ¾ HP motor.

16) 7'2" CDLR Full Pallet Transfer Conveyor: \$ 7,200.00

3000 lb capacity CDLR, 52" effective width, 11 gauge 2.5" rollers on 4 1/16"
centers, C6 x 8.2# drive channel, C5 x 5.4# idler channel and inclusive
of motor and gear reducer. 60 FPM. ¾ HP motor.

**17) 5' Powered Roller Conveyor Section Wrapper Infeed
Pallet Loading for Rewrap** \$ Included
with wrapper

52" BFR, 18" pass height, 60 FPM, 4000 lbs capacity

18) Wufitec WCRT-200 Rotary Tower Style Pallet Stretch Wrapper

The WCRT-200 is a tower style wrapper with a rotating arm holding the stretch film dispenser
that rotates around a properly positioned pallet.

The proposed model incorporates many standard features including:

- Up to 100 loads per hour

- 100% Heavy duty structural steel construction – No plastic
- 25" ring gear bearing w/ pinion gear drive and Automated remote lube station for the ring gear bearing
- 17 RPM variable speed rotary arm
- 1 HP 460VAC Motor & PowerFlex AC variable frequency drive programming features including Film consumption data monitoring
- Allen Bradley Color Touch Screen – We have refined our HMI over the last 15 years and continue to add new features to further enhance operator and maintenance experience.
- Superior Electrical/Control design including Allen Bradley CompactLogix PLC with Ethernet capability
- Wulftec's exclusive 20" NO-THREAD® Powered Pre-Stretch Carriage (30" optional)
- Heavy duty Metal cover protection on film carriage enclosing pre-stretch components and critical sensors.
- UL/CUL approvals
- 5,000 lbs load weight capacity (optional 6000 lbs)
- 5' in-feed/ 5' out-feed contoured powered conveyor with smooth transfer
- 11'6" wrap process contoured power conveyor with smooth transfer
- Standard pass height 18"
- 2- ½" diameter rollers on 3 ¾" centers, 52" standard infeed/outfeed conveyor width
- Auto film clamping device / Tilted clamp for clean release
- Standard heavy-duty safety fencing. The overall height of the fencing is 80" from the floor, with a 5.5" sweep space under the panels. Includes one interlocked access door with a tongue-operated guard-locking interlock switch to lock the door during operation and keeping it locked until the machine has come to a complete stop.

Power: 460VAC, 3 PH, Air: 3CFM@80 PSI

Wulftec WCRT- 200 Stretch Wrapper Base Price: \$ 69,700.00

Configured for your application:

30" NO-THREAD Powered Pre-Stretch Carriage \$ 900.00

In Cycle Top Sheet Dispenser \$ 22,900.00

With auto height sensing device, bottom film loading, double chain driven horizontal and vertical motions and lack of top sheet alarm. Also includes: 60" to 72" wide top sheet roll capacity Includes a 30" extension on the conveyor for the Top Sheet boom path.

Background Suppression Photoeye \$ 785.00

For dark or shiny loads autoheight detection.

Side Loading Capability on Infeed Conveyor Section \$ 750.00

Conveyor driving chains are situated on one side of the conveyor only.

This allows easy loading from the side of the conveyor in order to avoid double picking.

Extend Infeed Conveyor 1' for Side Loading \$ 795.00

Main Control Panel Cooling Fan

Addition of a 117 CFM cooling fan with filtered exhaust port on the main control panel for use in warm environments where ambient temperature is between 85° and 98°F.

\$ 385.00

Forklift Detection Photoeye

To disable conveyor while forklift is loading/unloading.

\$ 1,800.00

Wufltec WCRT-200 Stretch Wrapper w/options: \$ 98,015.00

19) 5' Powered Roller Conveyor Section – Wrapper Outfeed

52" BFR, 18" pass height, 60 FPM, 4000 lbs capacity

\$ Included with wrapper

20) 5' Powered Roller Conveyor Section

52" BFR, 18" pass height, 60 FPM, 4000 lbs capacity

\$ 5,520.00

21) 5' Gravity Roller Conveyor Section for Finished Pallet Pick

52" BFR, 18" pass height, 5000 lbs capacity and 2.5" dia. rollers on 1" shafts at 3" centers

\$ 2,725.00

Complete System Budget Price: \$ 620,620.00

Estimated Bagging System Startup Services

Hamer-Fischbein Technician, 1 Week (M-F), All Expenses Included, Customer will be billed at actual cost/expenses

\$ 10,000.00

Estimated Robotic Palletizing System Startup Services

Hamer-Fischbein Technician, 1 Week (M-F), All Expenses Included, Customer will be billed at actual cost/expenses

\$ 12,000.00

Estimated Wufltec Stretch Wrapper Startup Services

Provided by Wufltec Distribution Service Team. Customer will be billed at actual cost/expense.

\$ 4,000.00

Startup and training:

Start up services includes wiring inspection, air hook-up inspection, machine start up and operator training.

For bagging systems that include resale items such as:

- Thermal transfer or Ink jet printers
- Print and apply systems
- Check weighing systems
- Metal detection systems
- Or like purchased and integrated system components

Product training, technical support and on-going service support is provided by the original equipment manufacturer. Hamer will provide original equipment manufacturer manuals and contact information with system documentation.

Successful start up requires close coordination between the manufacturer and the customer. Attention to installation details and communication between both parties is essential.

Hamer technicians and/or Hamer contract technicians arrive fully prepared to start up and train your employees on your purchased equipment/system. For them to be effective in this important function, the following items must be completed by the customer prior to technician arrival:

- Machine installation by company millwright or contract riggers. Machine installation includes placement of Bagging machine, Scale or Volumetric Filler, Conveyors, Controllers, Palletizers, Wrappers and any required Support Structure assemblies.
- Installation of properly sized electrical service and compressed air lines with sufficient supply of clean dry air to meet specified machine air requirements.

A Hamer startup form, system drawings and supporting documentation will be provided at time of purchase.

Hamer-Fischbein Support Pro™ Start up, Training and Field Service Hourly Rate(s):

All travel expenses will be billed at cost. These expenses include; airfare, ground transportation charges, lodging and meals. Copies of receipts are available upon request. Car travel, other than rental where applicable, is billed at \$ 0.58/mile.

<u>Field Service Rates</u>	<u>Technician</u>	<u>Palletizer/Field Engineer</u>
Labor - weekdays	\$140/hour	\$165/hour
Labor - weekday overtime, weekends, holidays	\$185/hour	\$195/hour

Travel Time - weekdays	\$100/hour	\$110/hour
Travel Time - weekends, holidays	\$130/hour	\$150/hour

If there are reasons beyond our control, where the system start up is not able to occur (plant start up delays, training conflicts, power or air supply problems, film shortage or (other issues) and our technician is prevented or prohibited from performing their start up duties, the Customer will be charged our normal rates for the idle hours.

Terms:

40% down, 40% @ 60 days and balance 10 days before ship date.

All prices quoted in US Dollars; prices do not include misc. charges, freight, sales taxes.

Prices valid for 30 days

Delivery:

20-22 weeks from receipt of down payment.

Freight:

FOB Plymouth, MN ship via van lines

Crating charges may apply

Material/Product Testing:

Should a customer test be requested, test materials (product and film) will be provided at no cost to Hamer. This includes all associated freight to and from the test site.

Quotation preparation by:

Paul Solberg

Regional Sales Manager – Great Lakes

Direct 763.277.8709

Mobile 612.799.0053

paul.solberg@hamer-fischbein.com



A DURAVANT COMPANY

Model RPM™

Robotic Palletizer
Module

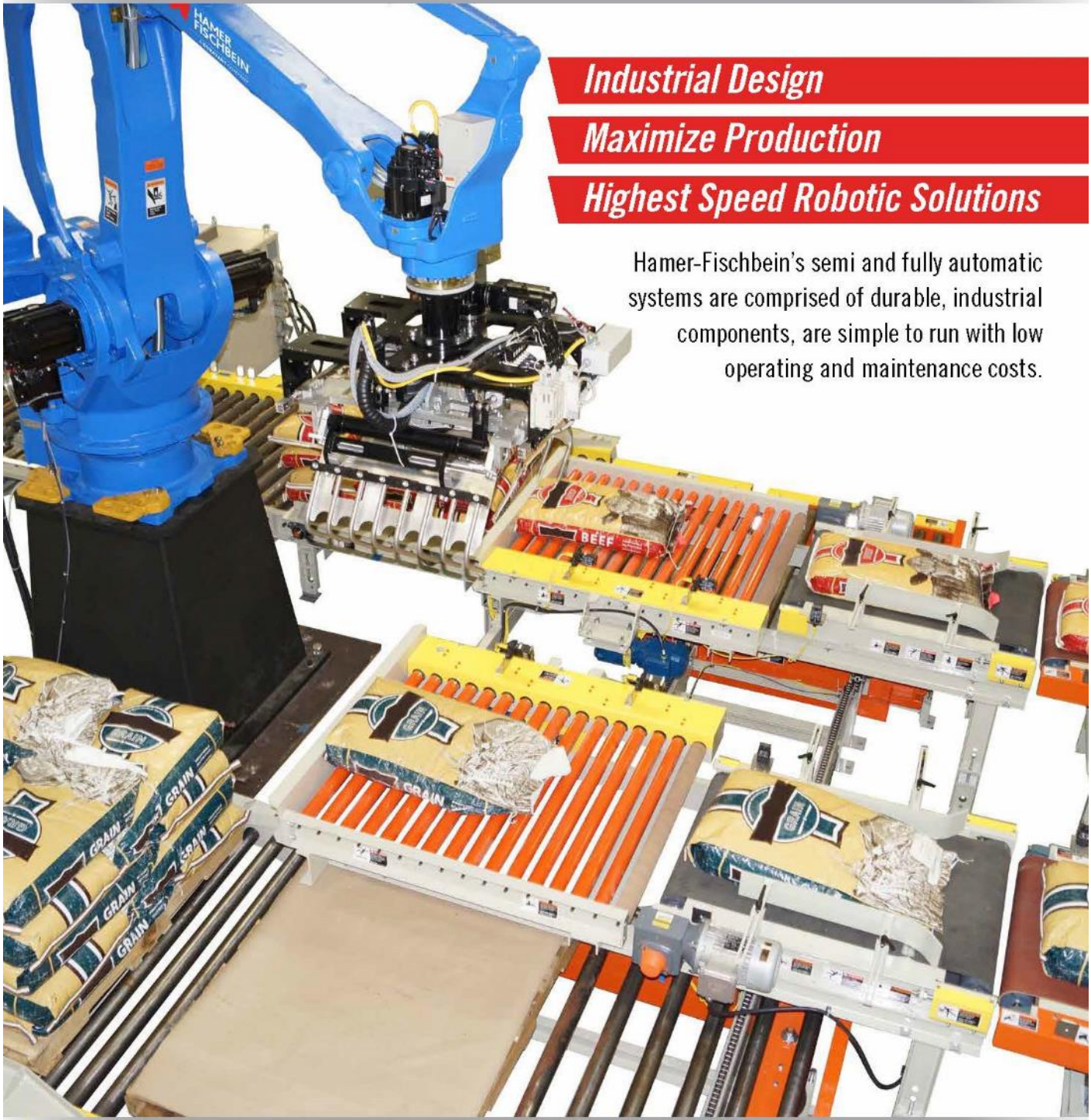

Industrial Design

Maximize Production

Highest Speed Robotic Solutions

Hamer-Fischbein's semi and fully automatic systems are comprised of durable, industrial components, are simple to run with low operating and maintenance costs.

Hamer-Fischbein Robotic palletizing sys

The Hamer-Fischbein Robotic Palletizing Module (RPM)™

Hamer-Fischbein robotic palletizers are completely assembled, wired and tested in our Minnesota manufacturing facility. Systems are wired with conduit and j-boxes to make system re-assembly and install in your facility fast and easy. All palletizers are programmed and tested on the specific products they will be running to ensure stack quality and speeds before they leave our factory.

Semi-automatic single or dual stack systems

- Small footprint
- Low cost, high productivity
- Single or dual cell configurations

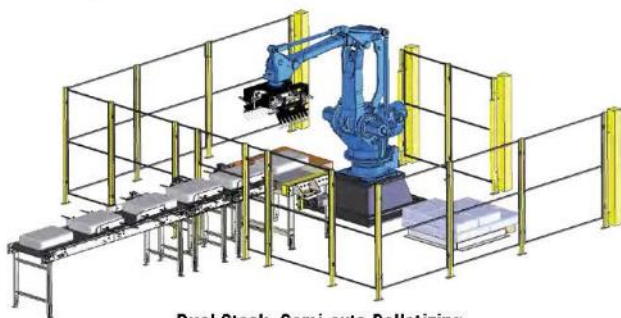

Dual Stack, Semi-auto Palletizing

Hamer-Fischbein semi-automatic palletizers are an efficient palletizing solution, providing 80% of palletizing automation at a significantly lower cost than fully automatic systems. Safety light curtains and controls ensure the robot is not active in a stacking cell when fork trucks are present. Semi-automatic palletizers can be configured in dual stacking cell (shown) or single stacking cell configuration.



Bag palletizing

Fully automatic palletizing systems

- Automate from bagging line to stretch wrapper
- 100% of palletizing labor is eliminated
- Highest production rates

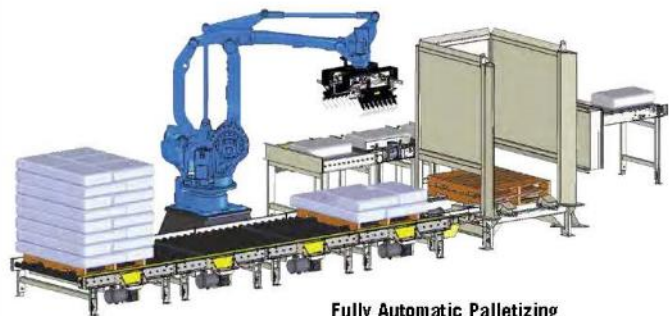

Fully Automatic Palletizing

To maximize impact of automated palletizing, the addition of a Pallet Dispenser, Slip Sheet Dispenser and fully automatic Full Pallet Transfer Conveyors provide a completely automated palletizing system. This system feeds empty pallets with or without slip-sheets automatically to the stacking area.

Products are then picked and stacked on the pallet. When complete, the full pallet is transferred to in-line stretch wrapping or stretch hooding equipment.



Pallet Dispenser

Slip Sheet Dispenser



tems—from simple to sophisticated

Exclusive EasyPic™ operator HMI MaxPic™ operating system

EasyPic™ allows for fast and easy adjustment to pallet stack, uploading stored pallet configurations or creating new pallet designs.

MaxPic™ incorporates Yaskawa Pallet Solver™ and EasyPic™ into one powerful programming, operational and multi-plant data share tool. With MaxPic™, pallet configurations designed on one line or at a single location can be transmitted and shared with all MaxPic™ configured Hamer-Fischbein Robotic Palletizers. Manage up to 40 SKU's with different pallet configurations at several locations. Program/set up at one location and file share between plants for automatic upload into any Hamer-Fischbein MaxPic™ system.

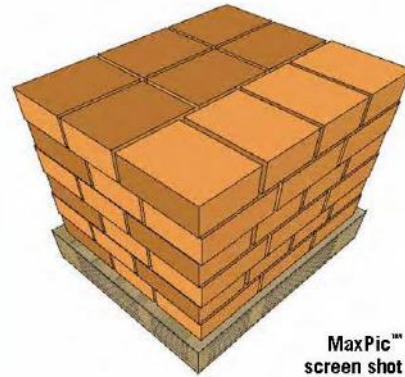

MaxPic™ screen shot

End Of Arm Tooling – EOAT

Hamer-Fischbein offers a wide variety of End of Arm Tools to meet any palletizer application. All EOAT solutions are solidly built, easy to maintain and deliver maximum performance. Single pick, multi-pick, gripper or vacuum are proven performers.

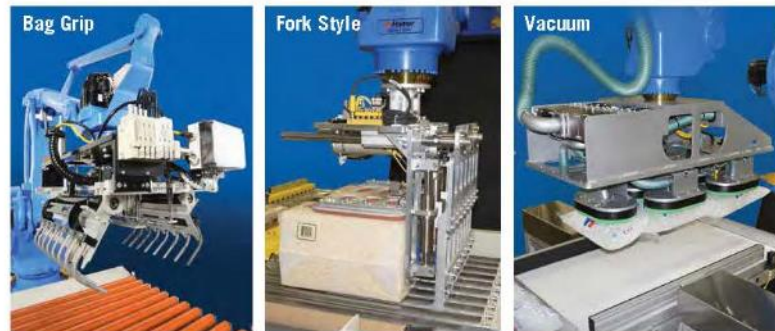

Case palletizing

Industrial, Heavy Duty Conveyors

Our palletizing system conveyors are designed for long life in virtually any plant environment. Roller to roller chain drive pick conveyors, direct drive pace and in-feed conveyors, all with 10 ga formed channel sides, powder coat finish, heavy-duty bearings and industrial grade belting and rollers. Our CDLR, chain driven live roller full pallet conveyors come in 3,000 lb. or 5,000 lb. and are built using 6" structural steel channel with powder coat finish.



Hamer-Fischbein™ Robotic Palletizing Systems

STANDARD FEATURES

- Fastest palletizing rates
- Bag, case, pail/bucket palletizing
- Small footprint systems
- Programmable/selectable pallet patterns
- Yaskawa/Motoman industrial robotic arm
- Allen Bradley® PLC with Touchscreen
- 160KG/320 lb capacity robot arm
- DX 200 robot control panel
- Robot mounting base
- Robot teach pendant
- Industry standard wire mesh safety guarding with interlock access door
- Safety compliant to ANSI/RIA Safety requirements

OPTIONS

- EasyPic™ Operator HMI
- MaxPic™ operating system.
- Fully automatic or semi-automatic systems
- Multiple robot arm models
- NEMA 4X controls and robot protection packages for corrosive environments
- Access to full line of Yaskawa/Motoman robots for custom solutions
- Corrosion resistant packages for conveyors
- Various power options
- Servo chiller for high temp
- End Of Arm Tooling:
 - Bag Clamp, single or multiple pick
 - Bag Clamp, fixed size, manually adjustable or, servo/automatically adjustable
 - Case Grip, single or multiple pick
 - Fork Style, multiple pick
 - Vacuum, single or multiple pick
- Multi-function end of arm tooling:
 - Pallet pick/place
 - Slip-sheet pick/place
 - Auto tool change
 - Auto height sensor
- Multiple pick points
- Multiple stack points
- Custom conveying for bag, case, bucket/pails conditioning, in-feed, pacing, picking, power curves, accumulating
- Automatic Pallet Dispenser
- Automatic Slip Sheet Dispenser
- CDLR full pallet conveyors
- 90 degree full pallet transfer
- Quad muting light curtains for continuous operation (semi automatic)
- Integrated automatic stretch wrapper or stretch hooder
- Automated, semi-automated or manual bagging systems

SPECIFICATIONS

Palletizing rates:

- Semi-auto, up to 22 per minute
- Single pick, fully automatic, up to 28 per minute
- Multiple pick, fully automatic, 40+ per minute (rates are pallet design/case/bag size dependent)

Power: 460V, 3 Ph, 60 Hz

Air: 2-10 CFM @ 80 PSI (design dependent)

Controls: NEMA 12 enclosure, UL/cUL

Safety: Design/Controls are compliant to ANSI/RIA requirements



800-927-4674

Your authorized Hamer-Fischbein representative:



Specifications are subject to change without notice.

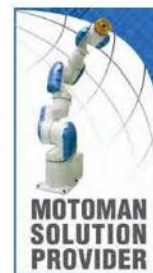



Model 600NW+
Model 200NW+
Net Weigh Scales

High Speed

High Accuracy

High Repeatability



The Hamer Models 600NW+ and 200NW+ are the only net weigh fillers available that offer combined high speed and high accuracy performance. These enhanced technology scales set a new standard for net weigh filling.

EVERYTHING IN BAGGING EQUIPMENT™



Faster Return on Investment

After years of research and hundreds of net weigh installations, Hamer-Fischbein engineering developed our new enhanced technology signal processing system. This new technology improves repeatable filling speeds by 20% and repeatable accuracy by 30%, taking net weigh performance into unheard of processing speeds and fill accuracy. When comparing Hamer 600NW+ and 200NW+ performance to other manufacturers' products, the results are startling.

ACCURACY (High speed, repeatable)

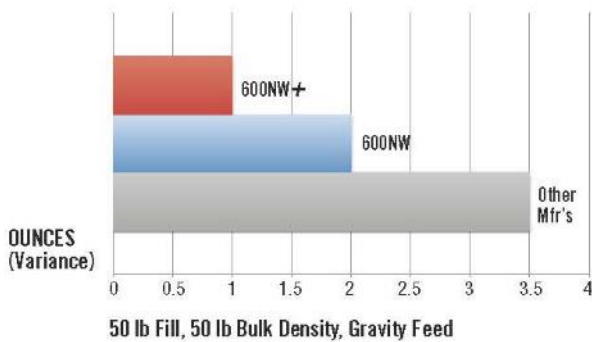

MAXIMUM SPEED (Simplex)

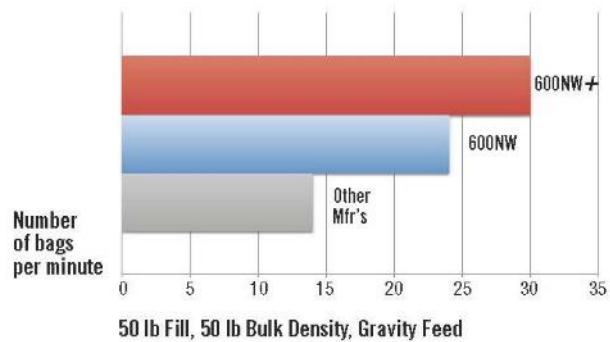

New 200NW+ Small Weighment

Based on the same robust design as the Model 600NW+, but in a much smaller format, the Model 200NW+ offers heavy-duty industrial quality dosing of small weighments. The all structural steel or optional stainless steel construction mirrors the Model 600NW+ design. Able to reliably process weighments of .5 lb to 30 lb, it processes at speeds of 30, 60, 80+ weighments per minute in Simplex, Duplex, Triplex or Quad configurations. Offered in pneumatic or servo controlled gravity feed configurations only.





Models 600NW+ and 200NW+

Fast, Accurate, Durable, Reliable

Increased accuracy reduces product giveaway. Direct mounted load cells featuring our exclusive "TrueWeight™" dampening system are faster responding and more accurate than traditional scale designs using transfer rods, flexures and suspended weigh hoppers.

Easy to maintain. Removable access doors on scale and feeder for product clean out. Simple design with few moving parts.

Fast processing time. Precision brad cells, cutting edge high speed electronics, and an aggressive weigh hopper design with steep door angles and expanded length/width dimensions speed material dispensing. No design is faster.

Steel Where You Need It™ Heavy gauge steel is used throughout the design, especially in the weigh bucket assembly. Hamer scales have almost twice the steel of competitive designs.

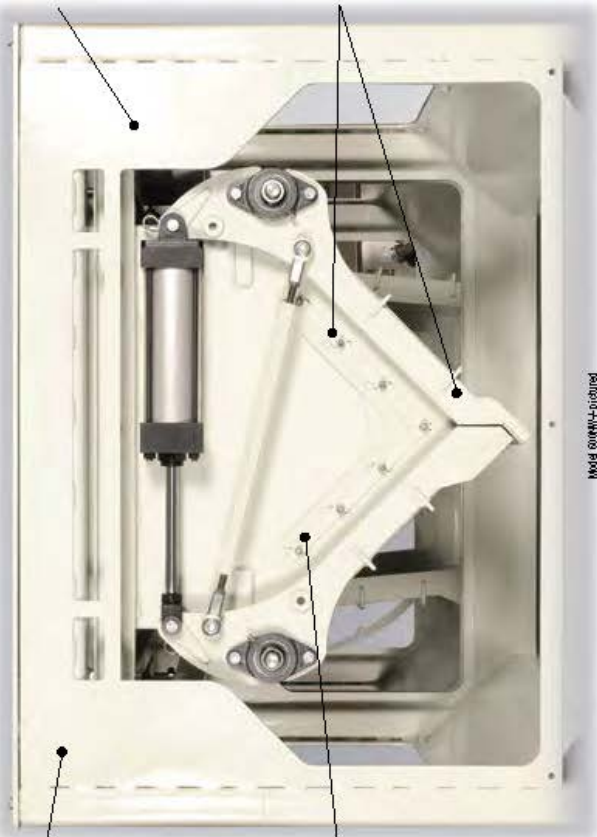

Model 600NW+ pictured



Model 200NW+ Triplex

The Model 200NW+ can be configured into a high speed Duplex, Triplex or Quad weighing system.

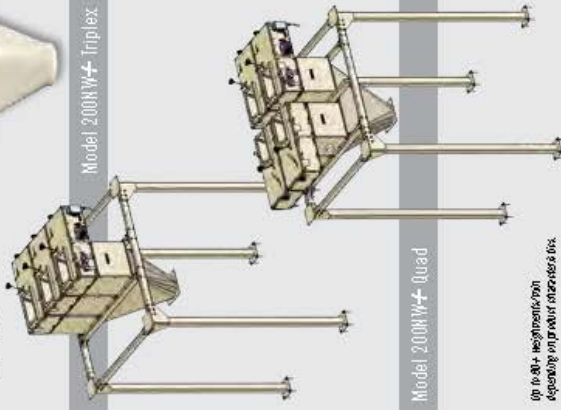

Model 200NW+ Quad

Up to 40+ weighments/min depending on product characteristics



GRAVITY

- Products: Free Flowing, Granular
- Heavy duty two position pneumatic control
- Easy adjust bulk/dribble



SERVO GRAVITY

- Products: Free Flowing, Granular
- Digitally controlled servo motor
- Precise control for bulk/dribble
- Extremely high speed



BELT

- Products: Semi-free flowing
- Two Speed VFD Controlled
- Exclusive side slide out
- Low drive/weight take up pulley
- Cut off gate



AUGER

- Products: Non-free flowing, Rouliders
- Two Speed VFD Controlled
- Dual Auger Design
- Pneumatic slide cut off gate
- Augers easily removed for cleaning

600NW+ Simplex		200NW+ Simplex	
Feeder	Gravity	Servo Gravity	Servo Gravity
Accuracy	Up to ± 0.5 cc. (15 g) @ 2 Sigma	Up to ± 0.5 cc. (15 g) @ 2 Sigma	Up to ± 0.5 cc. (15 g) @ 2 Sigma
Speed	Up to 25	Up to 30	Up to 30
Weight Range	10 lb to 110 lb (5 kg to 50 kg)	5 to 30 lb (2.3 kg to 13 kg)	5 to 30 lb (2.3 kg to 13 kg)
Weight Hopper Capacity	3.5 cu ft (100 cu m)	8 cu ft (220 cu m)	8 cu ft (220 cu m)

Speeds are dependent upon product flow characteristics, material size and weight class. Duplex, Triplex and Quad configurations provide higher speeds.

Corrosion Resistant Solutions

Bagging chemicals such as fertilizer, salt, calcium chloride, ice melt, and metal oxides with high corrosive properties can cause excessive wear and tear on your net weigh scale. The Hamer Model 600NW+ and 200NW+ are available in 304 stainless steel construction on the main scale assembly, and 304 or 316 stainless steel on contact points, gravity gate and weigh bucket.

Stainless steel gravity gate and weigh bucket, with hydraulic hinge.



Selecting the right material feeder



Product Characteristics

One of the most important aspects in defining the application of the proper scale is confirming your specific product characteristics. Product characteristics can include:

- Powder
- Non-Free Flowing
- Fines Content
- Granular
- Compaction
- Corrosive
- Free Flowing
- Aerated
- Sticky
- Large Non-standard Pieces
- High Moisture Content
- Hygroscopic
- Abrasive
- Dust Content

Mesh Size

Not all fine products are powders. When defining your product, confirm its mesh size. Mesh is determined by how many openings are required in a 1" square of screen to allow your material to flow. Consult a U.S. Mesh size chart to confirm your product's Mesh size. Typically products that are 200 Mesh or higher are considered fine powders.

Bulk Density

Bulk Density is typically provided in Pounds per Cubic Foot. For example many chemical fertilizer products range in the 50-65 lb per cubic foot bulk density. The higher the bulk density, typically the better (faster) the product will flow and the more weighments per minute you will achieve.

Flow Characteristics	Angle of Repose	Net Weigh Feeder Type
Very Free Flowing	Flows well at angles of 30 degrees and less	Gravity/Servo Gravity
Free Flowing	Flows well at angles of 30-45 degrees	Gravity/Servo Gravity
Sluggish	Flows well at angles greater than 45 degrees	Belt/Auger
Non-Free Flowing	Requires assistance to flow	Belt/Auger

Hamer™ Model 600NW+ and Model 200NW+

STANDARD FEATURES:

- High accuracy weighing
- High speed operation
- Heavy gauge steel weigh hopper
- Reinforced steel weigh hopper doors
- 4" (10.2 cm) dust collection port(s)
- Truweigh™ mechanical load damping
- Rugged platform style single point load cells
- Industrial air cylinders, valves and pneumatics
- Easy access removable scale side panels
- Easy access removable panels for feeder options
- UL Listed Controls
- Model 600NW+ Multiple Feeder designs include:
 - Gravity
 - Two Speed VFD Belt
 - Vibratory
 - Servo Gravity
 - Gravity/Vibratory
 - Dual Auger
- Model 200NW+ Feeder Designs
 - Gravity
 - Servo Gravity
- High resolution electronic scale indicator with:
 - Programmable Checkweigh
 - Scale status indicators
 - Surge hopper/silo fill level status
 - Simple programming screens
 - 100 product storage
 - Learn Pre-act

OPTIONS

- Hand Bagging Spouts: Center Grip, Dust Tight, Clamshell
- 304 Stainless steel construction
- 304/316 Stainless steel product contact
- Collating chutes for hand or automated bagging
- Linear actuator control on belt feed product gate
- Ethernet Connectivity
- Scale Support Structures
- Full bag conveyors, bag top closers
- Automated bagging systems

SPECIFICATIONS

- Two part epoxy paint
- Operating Temperature 40° F (4.4° C) to 110° F (43.3° C)
- Air: 8 cfm @ 80 PSI
- Power:
 - Gravity: 110 VAC, 1 PH, 60/50 Hz
 - Belt Feed: 230 VAC, 3 PH, 60/50 Hz,
 - Vibratory Feed: 230 VAC, 3 PH, 60/50 Hz
 - Controller: 110 VAC, 1 PH, 60 Hz, NEMA 6
- Scale Dimensions (approx):
 - Model 600NW+ L 52" (132 cm), W 29" (74 cm), H 47" (119 cm)
 - Model 200NW+ L 44" (112 cm), W 20" (51 cm), H 32" (81 cm)
- Weigh hopper sizes:
 - Model 600NW+ 3.5 cu ft (.10 cu m)
 - Model 200NW+ .8 cu ft (.02 cu m)

800-927-4674

Your authorized Hamer-Fischbein representative:



A DURAVANT COMPANY

Specifications are subject to change without notice.



14650 28th Ave. N • Plymouth, MN 55447-4821 • Tel: 763-231-0100 • Fax: 763-231-0101 • E-mail: packaging@hamer-fischbein.com

616



A DURAVANT COMPANY

Model
2090FFS™

Product cost reduction

Increased production

PROFIT...in the Bag™

Practical Innovation.

The 2090FFS reduces labor costs, improves production output while being easy to use, maintain & repair.



EVERYTHING IN BAGGING EQUIPMENT™



Next-generation engineering for greater speed, increases and expanded packaging versatility.

Durable

From the ground up the Hamer Model 2090 has been designed to improve uptime and production throughput. From the new main belt path to bag size changes, operator interaction has been significantly reduced. Our exclusive double sealed, self-cleaning pulley design requires no adjustment and keeps contaminants away from the belt path bearings.



Double sealed pulleys

Combining these next-generation design enhancements with a 50% reduction in wear parts, heavy duty air cylinders and an all new fill opening design, the Model 2090 brings industrial plant bagging automation into the 21st century.

Specifically designed to support a wide variety of bag sizes with minimal hardware changes, the Model 2090 with QuikAdjust™ reduces the bag change time required by previous HFFS machines or by vertical FFS machines by over 200%. Now even complex changes can be accomplished in less than 20 minutes. No other form, fill and seal machine can even come close.

Hot air sealing of bag tops has many benefits in industrial bagging. Fewer wear parts and efficient sealing (even with high dust products) are just a few. The new heat sealer design in the Model 2090 incorporates all we've learned in over 25 years of HFFS design. Double sealed bearings, reduced wear parts and a self opening feature opens the heat sealer when no bag is present. It automatically closes and is ready to seal the moment a bag is presented. By opening the sealer, pressure is removed from belts, pulleys and bearings, significantly increasing component life and reducing down time for maintenance. An optional bag jam detector can be added to stop a bag that is too full.



Model 2090 bag top sealer

Model 2090 pictured with optional second Vertical Roll Holder.

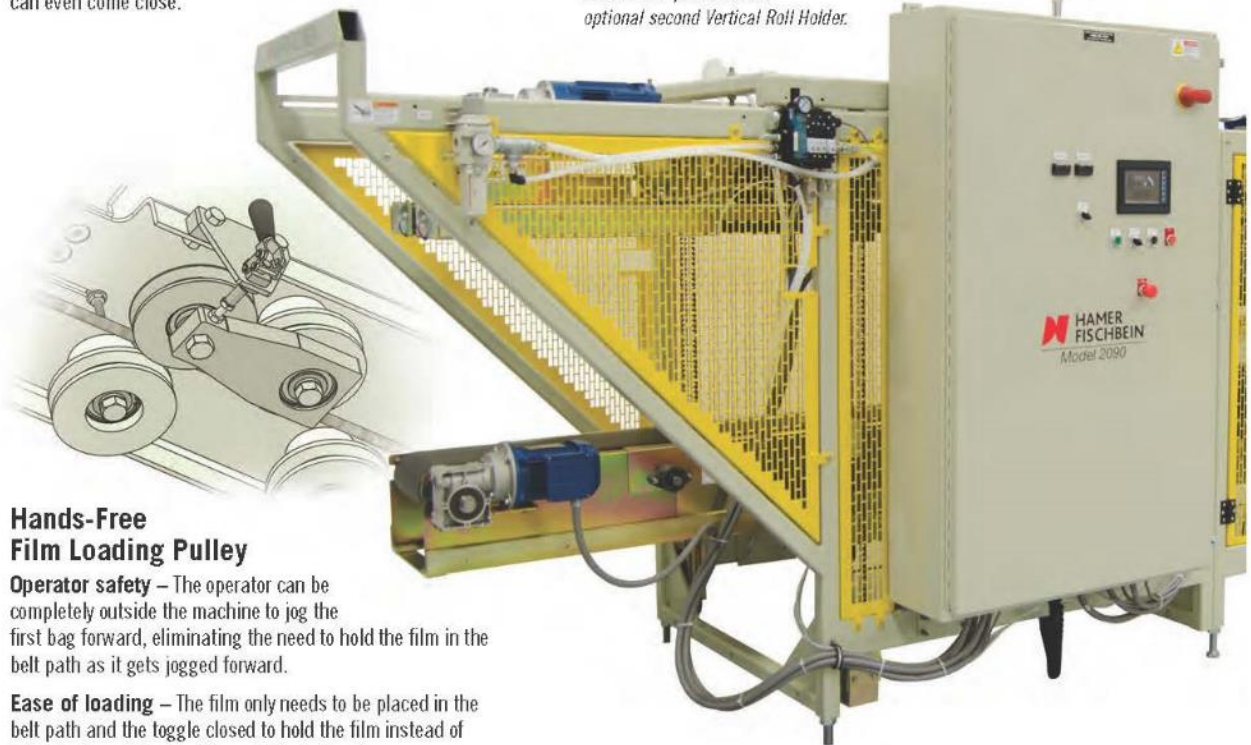

Hands-Free Film Loading Pulley

Operator safety – The operator can be completely outside the machine to jog the first bag forward, eliminating the need to hold the film in the belt path as it gets jogged forward.

Ease of loading – The film only needs to be placed in the belt path and the toggle closed to hold the film instead of trying to force it forward through the belt path.

ased throughput

Versatile

Built with a modular frame, the 2090 is the most flexible large bag packaging machine available today. A wide range of bag and machine options can be added during initial machine build or after installation as field add-ons. From date coding to on-demand printing or reclosable zippers to bag handles, now you can get custom bag features and the cost-saving benefits provided by bagging automation.



Easy to operate

On-demand thermal transfer printing

For automation to be successful in your plant, your operators need to be able to use the machine effectively. All Hamer equipment operates under the same basic design principle... keep it simple. The Model 2090 features improved operational software and a significant reduction in operator adjustments. These next-generation improvements speed training and improve production efficiencies. With the 2090, your operators can set it and forget it.



ROLL HOLDER OPTIONS

*PowerLift™
Roll Holder
option*



*EZ Load II™
Horizontal Roll
Holder option*



Fast

We call it MaxFill. The all new chute and jaw design featured on the Model 2090 provides more product volume than any other design. Maxfill gets more product into the bag, faster.

State of the art electronics and an all new belt path and jaw design complete the package. It's the fastest Horizontal Form, Fill and Seal available.

BAG TYPES, CLOSURES AND HANDLE OPTIONS

Bottom Gusset

Three to six inch bottom bag gusset.



Miter Corner

45° seal across corner improves pallet wrapping, reduces corner damage

Top Trimmed

Top two inches of bag removed.

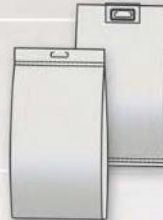

Handle

A variety of bag handle styles are available.



Model 2090 Industrial Horizontal Form, Fill and Seal

STANDARD FEATURES:

- 24VDC solid state controls
- Simplified operator touch panel
- Bag counting, Operational alarms & diagnostics
- Punched Metal Safety Enclosure with door interlocks
- UL Listed NEMA 12 control panels
- Hand held remote operator control
- SEW Euro-drive motors
- Five color spectrum photo eye with learn
- Top frame mounted internal components
- Automatic bag top heat sealer with auto-open
- 304 Stainless steel product contact points
- Single cylinder jaw assembly w/easy change features
- Proprietary heavy duty hardened self cleaning dual sealed pulleys
- Pre-Fill, Post-Fill bag staging for added seal integrity
- Variable speed AC motors on heat sealer
- Double heat seal with knurl for seal integrity
- 20" Integrated bag top seal cooling plenum
- Heavy duty powder coated 4" structural steel frame
- Zinc Dichromate plated internal components

OPTIONS:

- Second Vertical Roll Holder
- EZ Load II™ Horizontal Roll Holder
- JamControl™ overfilled bag detection
- Side of bag settler
- Bag settling conveyor
- Bag Handles:
 - Handle punch
 - Patch handle
 - Header/patch handle
- Bag coding
- Air removal devices
- On-demand thermal transfer printing
- Easy-open bag perforator
- Rotary bag top trimmer w/trim removal
- Mitered corner sealer (45° bag corners)
- Bottom gusset former, 3" to 6"
- Remote communications:
 - Ethernet, Web based, Modem
- 400V, 3 Phase, 50Hz
- Volumetric or net weigh dosing
- Full bag handling conveyors
- Fully automated palletizing and pallet wrapping
- Machine exposure door/panels in Lexan



Second Vertical Roll Holder option

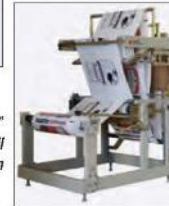

EZ Load II™ Horizontal Roll Holder option

SPECIFICATIONS:

Controls: NEMA 12 enclosure,  listed

Bag sizes range:

10¾" to 26" wide, up to 42" long

2 mil to 8 mil poly thickness

Film type: C-fold rollstock

Approximate machine size:

L 21' W 4' H 5'7"

Fill height 5'7"

Electrical: 240V, 3 Phase, 60 Hz, 40 FLA

Air: 35 CFM @ 80 PSI

Your authorized Hamer representative:

800-927-4674

 **HAMER
FISCHBEIN**
A DURAVANT COMPANY

Specifications are subject to change without notice.



14650 28th Ave. N., Plymouth MN 55447 • 763-231-0100 • packaging@hamer-fischbein.com • www.hamer-fischbein.com

4/19

REV	DESCRIPTION	DATE
01	CREATED LAYOUT	XX/XX/XX

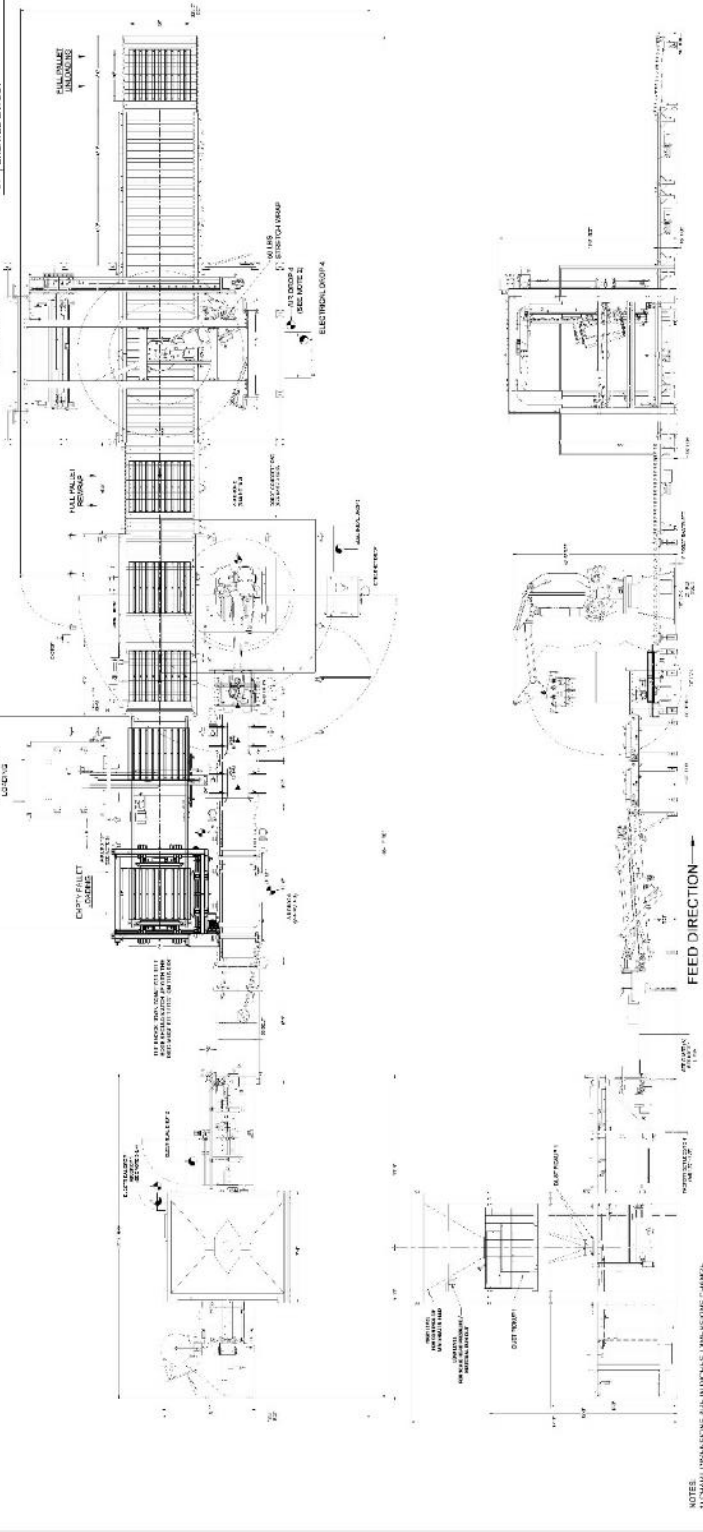

- NOTES**
- 1) CHANGING DIMENSIONS ARE IN PINK (SEE NOTES 2 & 3)
 - 2) MACHINES SHOULD BE LOCATED WITH A MINIMUM OF 3 FT. CLEARANCE TO ALL WALLS AND OTHER EQUIPMENT AS REQUIRED.
 - 3) WALLS AND CEILING SHOULD BE CLEAN DRY AND FREE OF OIL AND GREASE.
 - 4) ALL ELECTRICAL WIRING SHALL BE IN ACCORDANCE WITH LOCAL, STATE AND FEDERAL REQUIREMENTS.
 - 5) CONVEYOR BELTS SHOULD BE 1/2" THICK AND 1/4" TENSILE STRENGTH.
 - 6) CONVEYOR BELTS SHOULD BE 1/4" TENSILE STRENGTH.
 - 7) CONVEYOR BELTS SHOULD BE 1/4" TENSILE STRENGTH.
 - 8) CONVEYOR BELTS SHOULD BE 1/4" TENSILE STRENGTH.
 - 9) CONVEYOR BELTS SHOULD BE 1/4" TENSILE STRENGTH.
 - 10) CONVEYOR BELTS SHOULD BE 1/4" TENSILE STRENGTH.
 - 11) CONVEYOR BELTS SHOULD BE 1/4" TENSILE STRENGTH.
 - 12) CONVEYOR BELTS SHOULD BE 1/4" TENSILE STRENGTH.
 - 13) CONVEYOR BELTS SHOULD BE 1/4" TENSILE STRENGTH.
 - 14) CONVEYOR BELTS SHOULD BE 1/4" TENSILE STRENGTH.
 - 15) CONVEYOR BELTS SHOULD BE 1/4" TENSILE STRENGTH.
 - 16) CONVEYOR BELTS SHOULD BE 1/4" TENSILE STRENGTH.
 - 17) CONVEYOR BELTS SHOULD BE 1/4" TENSILE STRENGTH.
 - 18) CONVEYOR BELTS SHOULD BE 1/4" TENSILE STRENGTH.
 - 19) CONVEYOR BELTS SHOULD BE 1/4" TENSILE STRENGTH.
 - 20) CONVEYOR BELTS SHOULD BE 1/4" TENSILE STRENGTH.

HAMER LLC
 MINNEAPOLIS, MINNESOTA
 2080 FORM FILL AND SEAL
 HAMER ROBOTIC PALLETIZER

PLANT SETUP 15
 01 of 1

REV	DESCRIPTION	DATE
01	CREATED LAYOUT	XX/XX/XX

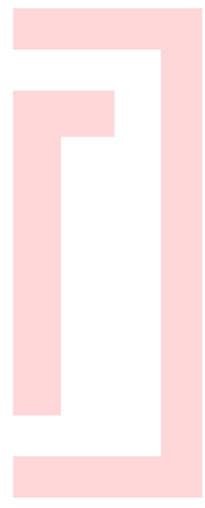



WULFTEC

A DURAVANT COMPANY

CONVEYORIZED
WCRT-175 WCRT-200

NON-CONVEYORIZED
WRTA-100 WRTA-150 WRTA-175 WRTA-200

4
YEAR
WARRANTY
WRT & WRTA
SERIES



WULFTEC® STRETCH WRAPPERS Automatic Rotary Arms

WWW.WULFTEC.COM
WE FEAR NO PACKAGING CHALLENGE



WCRF-175
Self-supporting
three-legged
model

WCRF Series:

- Optional elevating clamp for banding, separate double stack and one-way wrapping mode (WCRF-200)
- 5000 lbs to all components for trouble-free maintenance
- 1500 lbs to motor and gear for WCRF-175 and 200 (for option)
- Up to 60 loads per hour and more



WCRF-200
Self-supporting
four-legged
model



WRTA-100
Column-mounted
model

- WRTA Series:**
- 20" NO-THREAD[®] powered pre-stretch carriage with 50-300% pre-stretch
 - 25" ring GEAR bearing with pinion GEAR drive
 - 12 RPM variable speed
 - Unlimited load weight capacity
 - Heavy-duty structural steel construction
 - Superior protection against water and dust
 - Quick disconnect for fast and easy installation



WRTA-175
Self-supporting
three-legged
model



WRTA-200
Self-supporting
four-legged
model

WRTA-150
Floor-mounted
model



We'll Keep You Running at Peak Speed!

Why Choose Wulftec?

Superior safety features are engineered into every Wulftec machine. Wulftec's exceptional performance characteristics ensure reliability even in the harshest working conditions. It's important to get the best value for your investment. Why save a few bucks on a stretch wrapper if it can't handle the workload? A stretch wrapper that constantly breaks down can't guarantee a secure wrap and it certainly won't help you ship products on time. When it comes to strength and flawless performance, no other manufacturer can compare to Wulftec. That's because only Wulftec stretch wrappers are backed by the Wulftec Advantage. Just ask any end-user who relies on a Wulftec stretch wrapper to keep end-of-line production rates at maximum efficiency. "You simply can't get better value for your money!"

Why Go Automatic?

Automatic stretch wrappers are designed to maximize throughput and efficiency. They take care of everything, all you need to do is change the roll of film. An automatic stretch wrapper will save you significant time and money.

Benefits of a Rotary Arm

Rotary arm models, compared to turntable models, are designed for increased flexibility and for unique load shapes or weights. The rotary arm rotates around a stationary load; a safe, highly effective way of wrapping very light, tall, heavy or unstable loads.

The Wulftec Advantage

- Allen Bradley PLC for more flexibility
- AC variable frequency drives and motors
- Heavy-duty steel construction
- Non-proprietary parts
- NO-THREAD[®] powered pre-stretch carriage
- Quick disconnects throughout for ease of installation and maintenance
- Superior warranties

Wulftec Warranty:

- 4-year unlimited cycle warranty (3 years on the WCRF model)
- 10-year warranty on structural steel frame
- 10-year warranty on 25" ring gear bearing
- LIFETIME warranty on pre-stretch roller's sleeve compound



Features

- Allen Bradley variable frequency drives**
Wulftec was the first in North America to put AC variable frequency drives as standard equipment on all machines. Why? AC variable frequency drives and motors are safer, offer a more reliable performance and require minimal maintenance. Wulftec stretch wrappers will save you time and money.
- 20" NO-THREAD[®] pre-stretch carriage**
20" NO-THREAD[®] powered pre-stretch carriage for quick, easy, ergonomic and safe film loading. Our pre-stretch ratio goes from 50% to 300% for optimal film use and reduced costs. With our revolutionary spring loaded carriage gate, our carriages are "maintenance free".
Angled carriage to wrap approximately 2" from conveyor or floor to guarantee a secure load
- 25" ring gear**
Wulftec uses 25" ring GEAR bearing with pinion GEAR drive for unbeatable strength and durability. It's one of the main reasons we sell more rotary arm units than ALL other manufacturers combined. The ring gear bearing is warranted for a period of 10 years.
- Dual chain carriage lift system**
A dual chain carriage lift system and a dual structural steel boom improves machine security and assures stable lifting thus eliminating vibrations.
- Quick disconnects throughout**
Electrical and pneumatic components are quick-disconnect type for ease of installation and maintenance.
- Heavy-duty structural steel construction**
Wulftec stretch wrappers benefit from an all-steel structural design for superior strength. That's why our stretch wrappers are well-known for their exceptional strength, durability and reliability - no matter how heavy your environment for a period of 10 years. The structure is warranted for a period of 10 years.

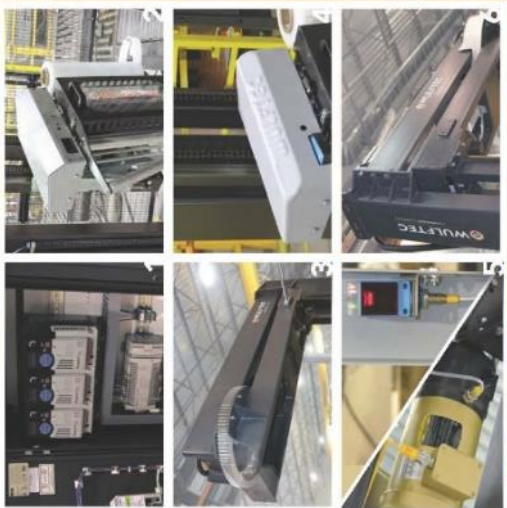

WULFTEC WE FEAR NO PACKAGING CHALLENGE

WWW.WULFTEC.COM

A QUANTRON COMPANY

Technical Specifications

	CONVEYORIZED		NON-CONVEYORIZED			
	WCRT-175	WCRT-200	WRTA-100	WRTA-150	WRTA-175	WRTA-200
Production Rate ¹	Up to 60 loads per hour	Up to 100 loads per hour	Up to 50 loads per hour	Up to 50 loads per hour	Up to 50 loads per hour	Up to 50 loads per hour
Max Load Weight	5,000 lbs (6,000 lbs optional)	5,000 lbs (6,000 lbs optional)	Unlimited	Unlimited	Unlimited	Unlimited
Max Load Size	48"L x 48"W x 80"H	48"L x 48"W x 80"H	54"L x 54"W x 80"H	54"L x 54"W x 80"H	54"L x 54"W x 80"H	54"L x 54"W x 80"H
Machine Dimensions ²	138"L x 141"W x 140"H	138"L x 148"W x 140"H	135 1/2"L x 130"W x 119 1/2"H	165 1/2"L x 130"W x 117 1/2"H	146"L x 130"W x 122"H	141 1/2"L x 130"W x 117 1/2"H
Approx. Shipping Weight	3,700 lbs	4,500 lbs	2,300 lbs	2,350 lbs	2,650 lbs	2,800 lbs
Electrical Requirements	230V/3/60	230V/3/60	120V/1/60 15A	120V/1/60 15A	120V/1/60 15A	120V/1/60 15A
Pneumatic Requirements	3 CFM @ 80 PSI; comes with Filter/Regulator		3 CFM @ 80 PSI; comes with Filter/Regulator			
Controls	<ul style="list-style-type: none"> NEMA 4/12 control cabinet with quick disconnect Touch screen operated controls Double brush dust tight slip ring 		<ul style="list-style-type: none"> NEMA 4/12 control cabinet with quick disconnect Separate up and down carriage speeds Separate top and bottom wrap selectors 			
Film Delivery System	<ul style="list-style-type: none"> 20" NO-THREAD[®] powered pre-stretch carriage with revolutionary spring loaded carriage gate 1 HP AC motor with variable frequency drive 50-300% pre-stretch 30" carriage available 		<ul style="list-style-type: none"> 20" NO-THREAD[®] powered pre-stretch carriage with revolutionary spring loaded carriage gate 1 HP AC motor with variable frequency drive 50-300% pre-stretch 30" carriage available 			
Film Tail Treatment	<ul style="list-style-type: none"> Automatic film clamping Pulse-controlled cutter Film alignment arm and brush treatment 		<ul style="list-style-type: none"> Automatic film clamping Pulse-controlled cutter Film alignment arm and brush treatment 			
Rotary Arm Drive	<ul style="list-style-type: none"> 25" ring GEAR bearing with pinion GEAR drive 1 HP AC motor with variable frequency drive 15 RPM variable speed (17 RPM up to 35 RPM on WCRT-200) 		<ul style="list-style-type: none"> 25" ring GEAR bearing with pinion GEAR drive 1 HP AC motor with variable frequency drive 12 RPM variable speed 			
Conveyors	<ul style="list-style-type: none"> Powered process conveyor 11'6" long Heavy-duty cast iron flange mounted bearings 2 1/2" diameter rollers on 3" centers 52" BFR (between frame rails) 		N/A			
Structure	Heavy-duty structural steel construction		Heavy-duty structural steel construction			
Warranty	<ul style="list-style-type: none"> 3-year unlimited cycle warranty 10-year warranty on steel structure 10-year warranty on 25" ring gear bearing Lifetime warranty on pre-stretch rollers' blue compound 		<ul style="list-style-type: none"> 4-year unlimited cycle warranty 10-year warranty on steel structure 10-year warranty on 25" ring gear bearing Lifetime warranty on pre-stretch rollers' blue compound 			



Reduced energy usage by throughput anticipation: Conveyorized automatic machines will operate at a lower speed when the throughput from the line is slower and speed up to allow production bursts. For an average production line³, the energy savings would equal 20 x 40 watt lamps lit for 6 hours!

Reduced film waste by optimized resolution: We use a higher resolution positioning system to deliver the film in a more accurate quantity. This means an average film reduction of 4 feet of film per pallet when compared to other control systems! That's 60 miles³ of unstretched film per year!

Reduced general waste by better product protection for handling and transport: With very low wrap capability, the product is properly secured to the pallet, resulting in a pallet that is more stable for transport and therefore less damage!

Reduced electricity consumption: By using variable frequency drives on all its motors, Wulftec ensures that only the power required by the load is used, regardless of the HP of the motor. By this, we have standardized our motor sizes, allowing for less parts in inventory for us and our customers. This translates into greener operations at our end and at your end.



1. Production rate based on load size and configuration
 2. Overall dimensions of the machine in operation
 3. Based on a production rate of 60 pallets per hour, 2 shifts, where 50% of the production is in "peak-mode", 250% pre-stretch
- All machine specifications are subject to change without prior notice / Nominal dimensions shown



WULFTEC

A DURAVANT COMPANY

Wulftec International Inc.
 209 Wulftec, Ayer's Cliff, Quebec, Canada J0B 1C0
 Toll free: 877.WULFTEC (985.3832)
 Phone: 819.838.4232
 Fax: 819.838.5539
 Email: wulftec@wulftec.com



WULFTEC IS A MEMBER OF THE DURAVANT FAMILY OF COMPANIES

PACKAGING SOLUTIONS | FOOD PROCESSING SOLUTIONS | MATERIAL HANDLING SOLUTIONS | SUPPORTPRO

www.duravant.com

Air Quality Control - Odor and Dust Control

Two equally essential considerations were addressed with our “Odor and Dust Control” design.

1. Follow all the appropriate legal and ethical standards respecting the environment and local EPA Air Quality Standards for a Metro Processing Facility.
2. We are protecting our employees from any health implications due to particulate dust inhalation. Notwithstanding the value of trained associates, maximizing employee retention - minimizing costly employees, our design minimizes chemical dust-related health and litigation issues.
3. The minimal odors associated with our process may have no legal or associated health issues. Odor complaints from the neighborhood would bring about nuisance investigations and place our operation forever under the public microscope. We believe it to vitally essential to avoid any such issues and design our plant as laid out in the current plans and specifications.

Baghouse

Our design includes a baghouse, also known as a baghouse filter, bag filter, or fabric filter is an air pollution control device and dust collector that removes particulates or gas released from commercial processes out of the air. Necessary millwright skills include installation, maintenance, and repair of industrial machinery and equipment. Using specialized tools, such as welders or hydraulic bolters, they align and replace a machine’s parts. They also move and relocate machinery on- and off-site.

Air Scrubber

Our design includes an air scrubber is a device that attaches directly to the ductwork of your HVAC system. It removes air pollution, VOCs, surface contaminants, pet dander, odors, and dust.

DRAFT

Midwest Mechanical Proposal

Westside Mechanical Group designed our Air Quality and Dust Control Systems under the “design Build” concept.



Founded in 1970, Westside Mechanical Group is a recognized leader in mechanical services in the Chicago area, employing over 350 professionals at annual revenues of \$100 million. We are a full-service mechanical contractor, and our abilities span a wide range of markets, industries, and mechanical systems.

Westside Mechanical Construction offers design/build construction services, innovative engineering, building information modeling (BIM) and 3D capabilities, LEED building sustainability and energy conservation, pipe and

sheet metal prefabrication, and installations performed by our sheet metal workers and pipefitters. Westside Mechanical Service, one of the largest service companies in the Chicago area, offers 24/7/365 emergency services and excellent preventative and full-service maintenance programs customized to meet our clients' needs. Our service coordination utilizes state of the art technology to help manage and run over 30 service technicians on the streets every day servicing our customers. We offer 24-hour service, navigation on our trucks, with our service technicians working paperless, utilizing iPads for all work orders, service calls, and maintenance inspections. The Mission at Westside is simple: Hire the absolute best people, provide them with unparalleled training, encouragement, and support, and together deliver the best possible product and service to our customers, always striving to exceed their expectations.

Previous Projects

<p>LYONDELLBASELL</p> <p><i>Location: Morris, IL</i></p> <p><i>Size: 100,000 SF</i></p> <p><i>Value: \$3.3 M</i></p>	<p>PETAG</p> <p><i>Location: Hampshire, IL</i></p> <p><i>Size: 123,000 SF</i></p> <p><i>Value: \$780,188</i></p>
<p>GLANBIA</p> <p><i>Location: Downers Grove, IL</i></p> <p><i>Size: 20,000 SF</i></p> <p><i>Value: \$833,591</i></p>	<p>DUPAGE MACHINE</p> <p><i>Location: Bloomingdale, IL</i></p> <p><i>Size: 92,000 SF expansion</i></p> <p><i>Value: \$1 M</i></p>
<p>PROJECT CONDOR</p> <p><i>Location: Monee, IL</i></p> <p><i>Size: 1,000,000 SF</i></p> <p><i>Value: \$3.5 M</i></p>	<p>Westside Mechanical Group</p> <p><i>Innovative Excellence in Mechanical Services</i></p>  <p>www.wsmech.com 630.369.6690</p>



Westside Mechanical Group
2007 Corporate Lane
Naperville, IL 60563
Tel: 630-369-6690

January 15, 2021

Lynam
Mr. Bartholomew R. Lynam

Re: Biosource HVAC and Process Mechanical Systems

Dear Bart,

We are pleased to quote on the Budget pricing for the new mechanical work as described below per the conceptual drawings and our multiple scope meetings.

Under this proposal, we will furnish and install a complete system including;

- Truck Unloading Dock:
 - One (1) 12,000 cfm roof garage exhaust fan (6 ACH).
 - One (1) 84x48 intake louver and motorized intake damper.
 - Carbon monoxide controls to automate garage exhaust system of fan/intake damper BY OTHERS.
 - Dust collection exhaust serving the unloading pit shall consist of two (2) vertical hoods on each side of the pit (3,000 cfm ea):
 - Each of two vertical plenums shall be 14x14x84h with two (2) 72x1 slots vertical slots and equipped with volume dampers at the 12" dia outlet.
 - Extend 12" dia dust collection ductwork vertically and combine the slot hood exhaust with one 18" dia dock exhaust main back to the 24" dia main inlet to the duct collector.
 - One (1) 18" dia motorized damper serving the dock exhaust main.
- Material Storage and Blending Room:
 - Each of eight (8) large material storage bins shall be equipped with: one (1) 16" dust collection duct connection to the top rear of the bin; and one (1) 10' long supply air plenum above the 10x10 material storage bin permanent opening.
 - One (1) 16" dia dust collection duct (5,000 cfm) shall extend from each of the eight (8) bins and connect to the dust collection main and be equipped with a motorized damper.
 - Provide six (6) 12" dia dust collection ducts to each of six total material loading hopper hood and include motorized damper.
 - Provide six (6) 6'x8' loading hopper hoods. Curtains shall be provided and hang from the hoods on the rear and sides and 3' from the hood at the front to minimize airflow requirement to 3,000 cfm.
 - Provide one (1) 8" dia dust collection duct to the blender.

Continued on Page 2



Page 2

- Bagging Room:
 - Extend one (1) 10" dia dust collection duct to the bagging room from the 16" dia.
 - One (1) 5" dia dust collection ducts (two total, 500 cfm ea) shall extend from the 10" dust collection duct serving the bagging room to each bagger (two total baggers).
 - One (1) 5" dia dust collection ducts (two total, 500 cfm ea) shall extend from the 10" dust collection duct serving the bagging room to each bagger (two total baggers).
 - Provide four (4) total 5" dia motorized dampers for the ducts serving the baggers and floor sweeps.
- One dust collector (27,000 cfm) shall be provided with cleaning system, filtration, return filtration, 1" 30scfm 90 psi compressed air. Include blast gate in the exhaust duct at the wall penetration.

HVAC work included:

- Engineered design drawings for permit and coordination purposes.
- Four-(4) RTU's.
- Two-(2) make-up air units.
- One-(1) large roof exhaust fan.
- Six-(6) small roof exhaust fans.
- One-(1) air compressor and piping to the dust collector.
- Natural gas piping.
- Sheet metal ductwork and hoods.
- Installation of the dust collector. Concrete pad by others.
- Roof curbs and coordination with the roofer.
- Registers and grilles.
- Motorized dampers.
- Duct insulation.
- Crane and man lift rentals.
- Complete start-up by a qualified service technician.
- Air test and balance work.

Note, two items also included in this budget are:

- Two-(2) ambient air cleaning systems for the loading and skid steer area of the building. This is for the material that gets dropped by the skid steer and then run over and turned into a power in the air.
- One-(1) industrial combustible dust central vacuum system with cyclone filter silo fitted for a 55-gallon drum, cartridge filtration with pneumatic purge and HEPA. This is for the bagging area clean up when material is dropped on the floor.

Continued on Page 3



Page 3

This proposal will carry a one (1) year warranty from the date of completion of the work.

The above will be performed during normal working hours, Monday through Friday, excluding holidays and weekends.

All the above will be performed for the Budget sum of: \$1,186,040.00

This proposal does not include the following; temperature controls since John Sudnick is working on the sequence of operation for the process and mechanical systems, existing warehouse heating, exhaust and make-up air since it is "assumed" to be existing, structural steel, roofing, concrete pads, cutting and patching, permits, bonds and fees.

This proposal is valid for sixty (60) days.

Regards,

Westside Mechanical, LLC

A handwritten signature in black ink, appearing to read 'Scott D. Egger', is written over a horizontal line.

Scott D. Egger
V.P. / Sales Engineer

ACCEPTED FOR:

BY:

TITLE:

DATE:

PURCHASE ORDER NUMBER:

Integrated Controls

We have included in our Operating budget and Financial Models the costs out integrated controls to sequence the equipment for smooth operations.

Integrated Control Technologies, LLC is our current controls contractor.



Integrated Control Technologies, LLC (ICT) is a leading building automation contractor for Northern Illinois. As a Tridium / Vykon, Honeywell, and an American Auto-Matrix dealer, ICT can meet all your integration and automation needs.

ICT provides quality products, professional experience, and outstanding customer service while crafting creative and cost-effective solutions. We are factory distributors of several quality products such as Tridium / Vykon, Honeywell WEBS, American Auto-Matrix, and multiple HVAC control accessory goods, including Variable Frequency Drives. Our staff is always ready to draw on their experience and apply our record of first-rate control products and services to meet any challenge that may arrive.

Our Mission Statement:

Integrated Control Technologies, LLC is dedicated to providing superior technical expertise, unsurpassed installation quality, and cost-competitive services relating to all aspects of building automation, thereby allowing customers to focus on the specific demands of their business continuously.

DRAFT

Small Equipment CapEx

We have included in our Operating budget and Financial Models the Lease cost for all our Small Equipment and Pallet Racking needs.

Komatsu Forklift of Chicago



We are wholly owned by Komatsu Forklift USA who manufactures our products in Newberry, SC, and you can count on us to provide new forklifts, used forklifts, rental forklifts, forklift parts, forklift service, and forklift leasing plans to meet any budget in the Chicago Metro

Area.

We are local with timely service for repairs and parts. We offer New as well as leased equipment.

Phillip Nocerino - As your account manager, I offer 28-years' experience assuring you get the right equipment with the best value in the marketplace.

NARROW AISLE - FR50 Series, Single/Double Reach



Komatsu's FR Series of narrow aisle reach trucks feature new and innovative engineering ideas that show Komatsu's commitment to conserving our environment and reducing your overall ownership costs. AC drive and hydraulic controls offer smooth and efficient control of critical trucks' functions while giving you extended run times and improved truck efficiencies. When gauging truck productivity, it is essential to look at the overall cycle times necessary to perform in the workplace. With the FR Series, you have an exceptional blend of fast and efficient proportional hydraulic operation, responsive

steer-by-wire maneuvering, and a rugged and dependable drive system that allows for quick and efficient operation.

JCB Teleskid's Telescopic Boom Gives Skid Steer More Than 13 ft. Dump Height



74 Horsepower; This large platform vertical lift compact track loader incorporates JCB's unique Power Boom and exclusive side door entry design. Designed for comfort, safety, economy, productivity, and durability in the USA (home of tracked loaders), the 260T's 74-horsepower (55 kW) JCB EcoMAX engine is durable and hugely efficient. The JCB 260T Compact Track Loader for rent has on average 60% better visibility and a 33% larger cab than rival manufacturers' tracked skid steer loaders, and there are a whole host of other benefits as well. Like ergonomic controls, an extremely tough, powerful boom, and a low cost of ownership.

Pallet Lift Costs and Specs and Used Pallet Truck Pricing



2010 YALE NTA030SB

Swing Reach Forklifts

USD ▼ **\$34,900**

Technical specs - NTA030SB Yale

Notice: LECTURA Specs team experts verify every data listed. However, incomplete data and mistakes might occur. Contact our team with any change suggestion.

Nominal load at COG	1.36 t
Wheelbase	2.063 m
Standard tires	13.78x5.5 / 16x7
Transport length	3.894 m
Transport width	1.775 m
Transport height	4.74 m
Lifting height	13.4 m
Centre of gravity	610 mm
Weight	7.034 t
Battery weight	1.26 t
Traction motor	7.5 kW
Hoist motor	2x12 kW
Battery capacity	48/1240 V/Ah
Travel speed with / without load	10.46 / 10.46 km/h
Hoisting with / without load	0.33 / 0.42 m/s
Lowering with load	0.48 m/s
Turning radius	2.37 m

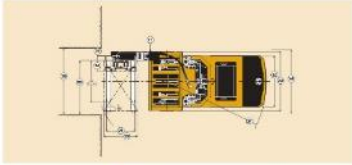

2007 YALE NTA030SB
Swing Reach F
For Sale Price: USD \$28,900

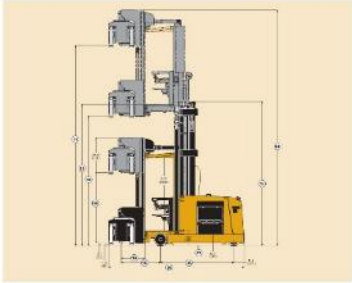

<https://www.machinerytrader.com/listings/construction-equipment/for-sale/list/manufacture/yale/model/nta030sb>

Purchase today for USD 485.67/monthly*

Drive: 2 WD

ROPS: Enclosed

Load Capacity: 3,000 lb.

Condition: Used

322" Mast, Narrow Aisle Turret Truck - Freezer Package!! Enclosed Cab, Clean!! Not your typical freezer type truck!!

The battery is 2015!!! 48 Volt, Serviced & Delivered

Skid Steer Front End Loaders

JCB Wheeled Telescopic Skid Steer 3TS-8W \$65,000.00/\$1,169.00 per month



Battery and Propane Management

Included in our business models are the costs for:

- Spare Batteries and Storage
- Spare Propane and Storage

Pallet Racking System

We have based the property selection and warehouse needs using a “Narrow Aisle Pallet Rack System.” Narrow Aisle Pallet Racking offers the following features and benefits as standard:

- Total and unrestricted accessibility to individual pallets
- Optimum configuration for maximum storage, density, and efficiency
- Any additional costs offset by the added value of improved space

The Narrow Isle Pallet System

To minimize the square footage and long-term lease exposure, we have engineered a “Narrow Isle Racking” system. A Narrow Isle Racking” system requires the use of a narrow aisle pallet truck.

Below are infographics for Narrow Isle Racking and a Narrow Isle Pallet Lift Truck

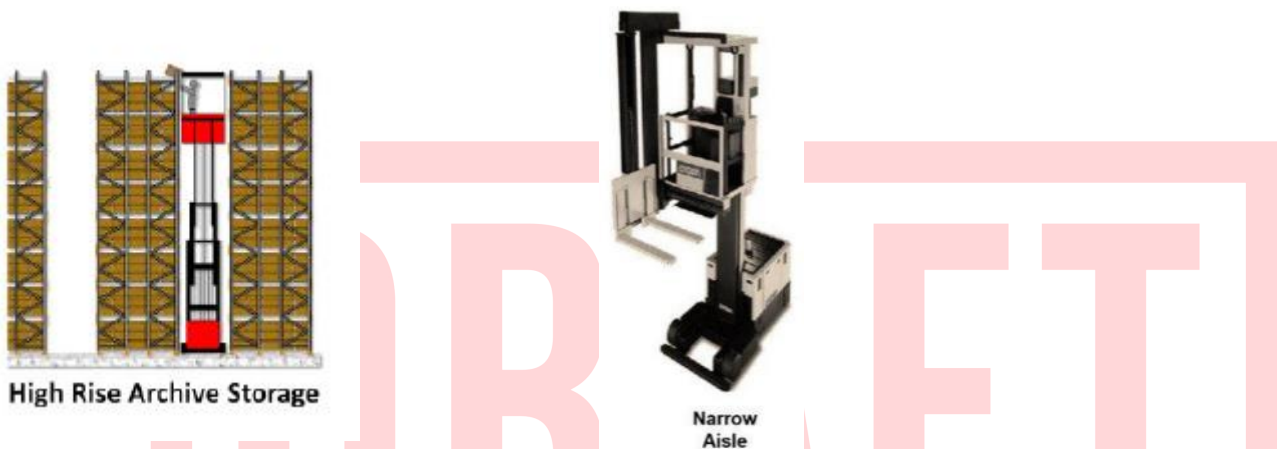

Pallet Racking - Fire Sprinkler Considerations

We have discussed Pallet Sprinkler considerations with the local fire marshal for Bolingbrook, IL. The Fire Marshal informed us that there are not typically any sprinkler issues with open bottom Pallet Racking Systems.

DAK Equipment & Engineering Company



DAK Equipment & Engineering develops warehouse solutions for companies in Chicago and across the United States. Our automated material handling solutions and warehouse equipment help companies streamline their warehouses, using their space and human resources more efficiently. Learn more about our warehouse solutions from our team of experienced, professional warehouse consultants. Explore our website to learn more, then contact us and let us know how we can help your

business find the warehouse solutions & equipment that you need!

We partner with clients to provide optimal solutions to business problems: integrated material handling systems that address our client's specific needs. We plan and layout facilities, provide various services, design, and build storage systems and integrated material handling systems, and deliver value-added solutions to our clients.

Chris Andersen National Account Manager and Industrial Engineer at DAK Equipment & Engineering Company. Design and development, sales, implementation, and management of material handling system solutions, including pallet racking, shelving, mezzanines, plant office, conveyors, and other autonomous systems.



EQUIPMENT AND ENGINEERING COMPANY

Investment Summary

Estimated Lead Time: 10-11 weeks

Material: \$1,016,865.00

Estimated Material Taxes:	Any applicable taxes
Estimated Freight:	\$40,615.00
Installation:	\$104,275.00
Drawing Set:	\$350.00
Permit Procurement:	\$200.00
PE Stamp:	\$3,000.00
Total:	\$1,165,305.00

Credit cards are subject to a 3% transaction fee.

Above pricing based upon approved credit and the following payment terms:

33% down payment required by factory is due with order (order will not be entered without payment.)

34% upon shipment of material. Net 10 days.

33% upon completion. Net 10 days

Other payment terms are subject to DAK approval and may result in additional cost.

Proposal Expiration Date: 12-23-2020

Customer Acceptance

Please provide the entire updated proposal with the signature page	
Printed Customer Name and Title:	
Customer Authorized Signature:	
This acceptance will serve as notice that DAK Equipment & Engineering Co. is authorized to begin final engineering and preparation of factory orders for this project. An official purchase order from the customer is required in follow up via email, fax, or hard copy letter format. The following Terms & Conditions will apply. Proposal submitted by: Chris Andersen	



EQUIPMENT AND ENGINEERING COMPANY

Lease Summary

Lease	36 mo.	48 mo.	60 mo.	72 mo.	84 mo.
Monthly Payment	\$ 28,967.97	\$ 22,801.87	\$ 19,399.30	\$ 17,380.99	\$ 15,728.70
Total Investment	\$ 1,042,846.92	\$ 1,094,489.76	\$ 1,163,958.00	\$ 1,251,431.28	\$ 1,321,210.80

Buyout	36 mo.	48 mo.	60 mo.	72 mo.	84 mo.
Monthly Payment	\$ 34,632.86	\$ 26,599.14	\$ 21,796.91	\$ 18,663.18	\$ 16,669.11
Total Investment	\$ 1,246,782.96	\$ 1,276,758.72	\$ 1,307,814.60	\$ 1,343,748.96	\$ 1,400,205.24

Fair Market Value Lease – Customer has option to return at end of term, purchase at fair market value, or extend lease.

Buyout – Customer owns the equipment at the end of term

Terms & Conditions of the Leasing Summary

- All opportunities are subject to full credit review and approval by First Financial and its respective Credit Committees
- Pricing is based on a maximum soft cost allowance of 35%. If soft costs are greater than that, please call your sales representative.
- Pricing is based on the like term swap rates posted by the InterContinental Exchange, Inc. (ICE). The lease rates quoted are subject to change, and in the event this index fluctuates prior to lease commencement, the monthly rate will change accordingly and the lease rate factor will be fixed during the stated lease term.
- In the event of a material adverse change or material disruption of conditions in either (1) the financial, banking or capital markets, or (2) the customer's financial or creditworthiness, First Financial may amend this pricing.

DRAFT

Exhibit – C Drawings – Design/Development

In House Conceptual Design Drawings

We authored detailed in-house concept drawings.

These concept drawings were used as a basis to initiate design and revised many times to arrive at a set of conceptual drawings sufficient to acquire reliable pricing from our design team, equipment suppliers, and major subcontractors.

Conceptual Drawings:

A conceptual plan is a scaled drawing to help explain what will fit on the site.

It provides a starting point to help begin design and pricing discussions.

We provided these drawings to our chosen consultants, engineers, architects as a base point.

The concept design represents our understanding and intent on the project.

During the concept design stage, we developed:

- The design concept.
- Outline specifications.
- Property Selection Criteria
- Storage needs
- A planning strategy.
- The cost plan.
- Procurement options.
- Program and phasing strategy.
- Buildability and construction logistics.

DRAFT

CS 1.0 - Floor Plan

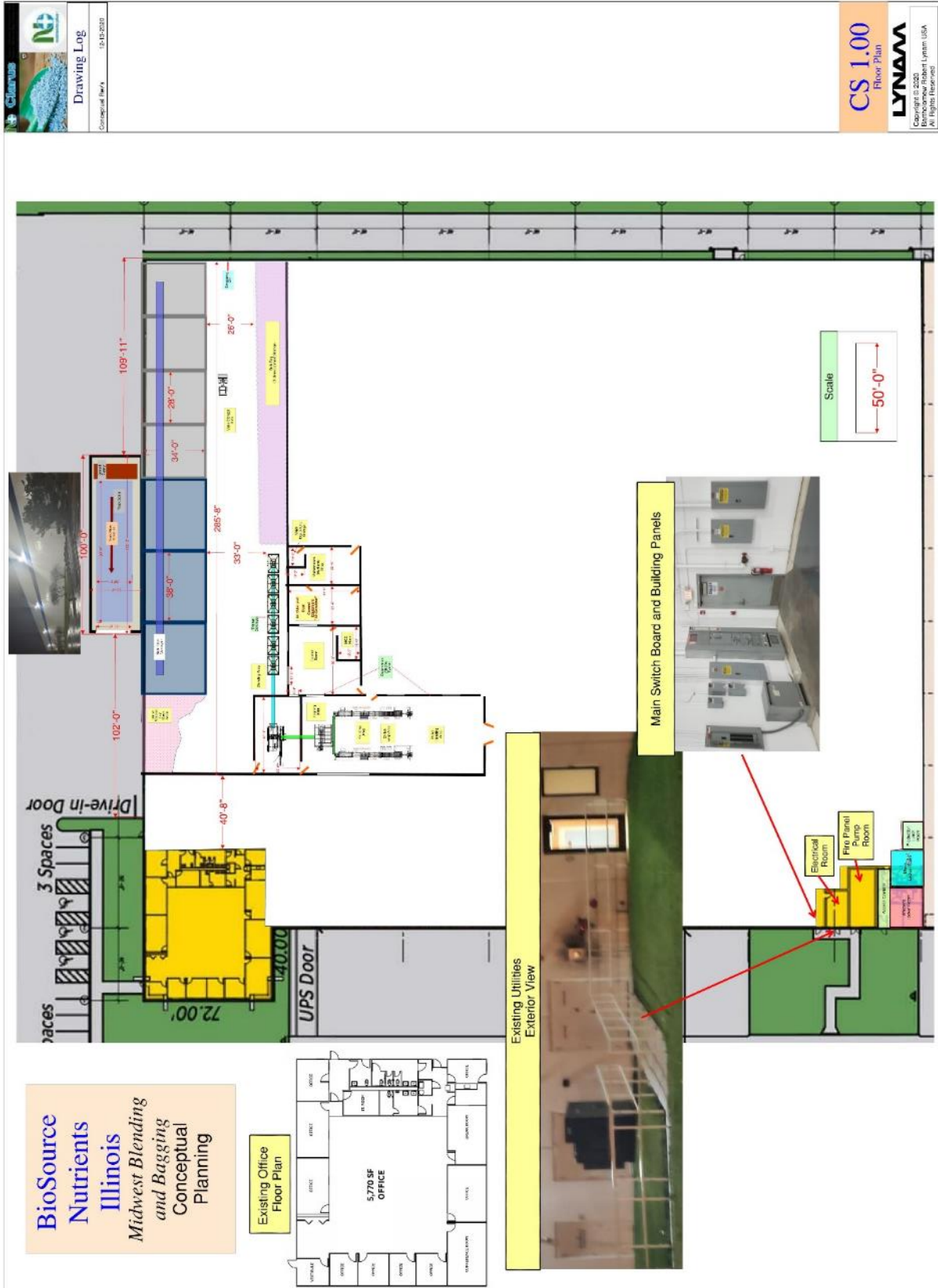

CS 1.10 – Property Square Footage Breakdown

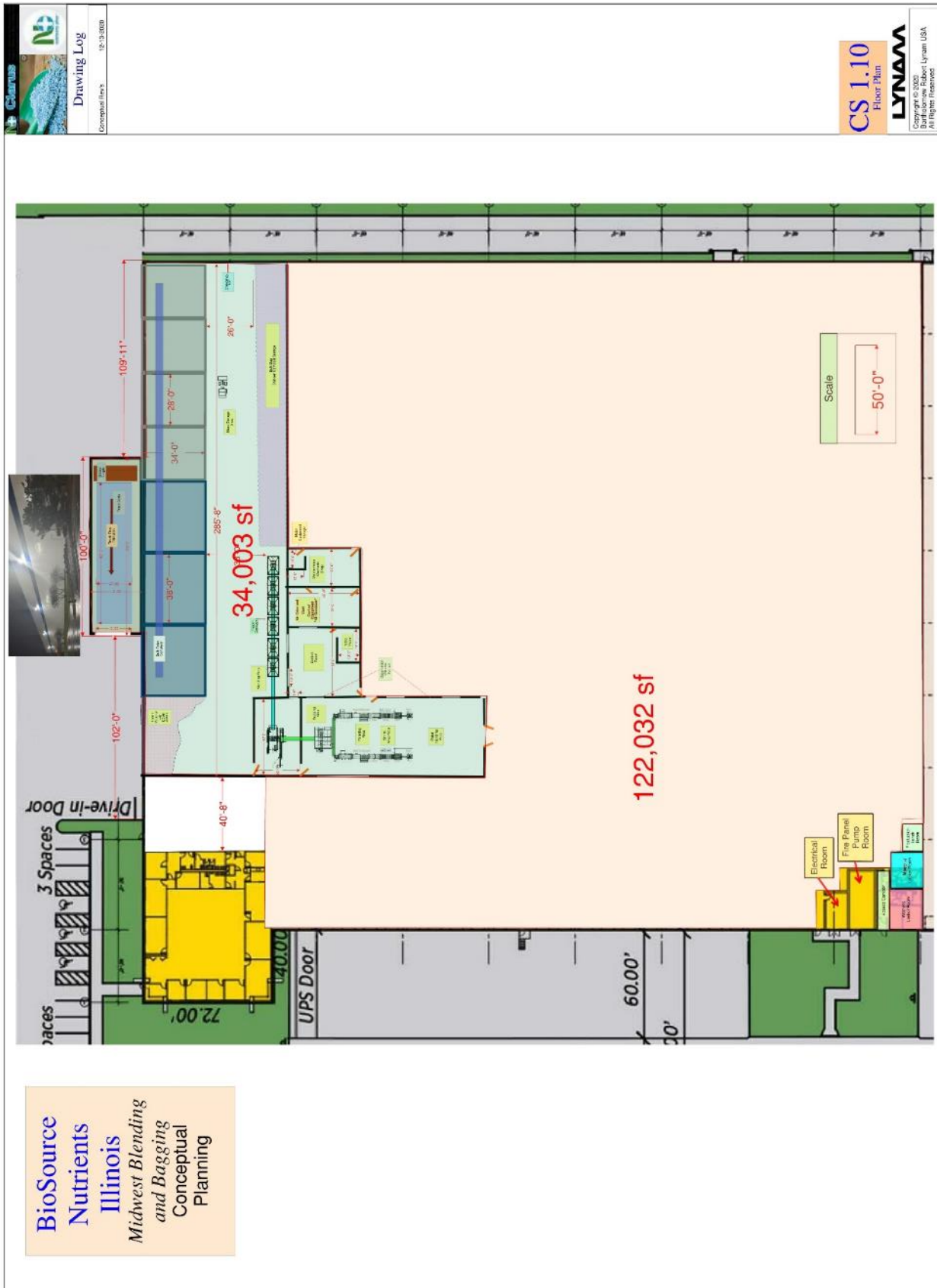

BioSource
Nutrients
Illinois
Midwest Blending
and Bagging
Conceptual
Planning



 Drawing Log
 Conceptual floor
 12-13-2020

CS 1.10
 Floor Plan

 Copyright © 2020
 by Lynam Engineering, Inc.
 All Rights Reserved.

BioSource Nutrients Illinois LLC
Midwest Blending and Bagging
Conceptual Planning

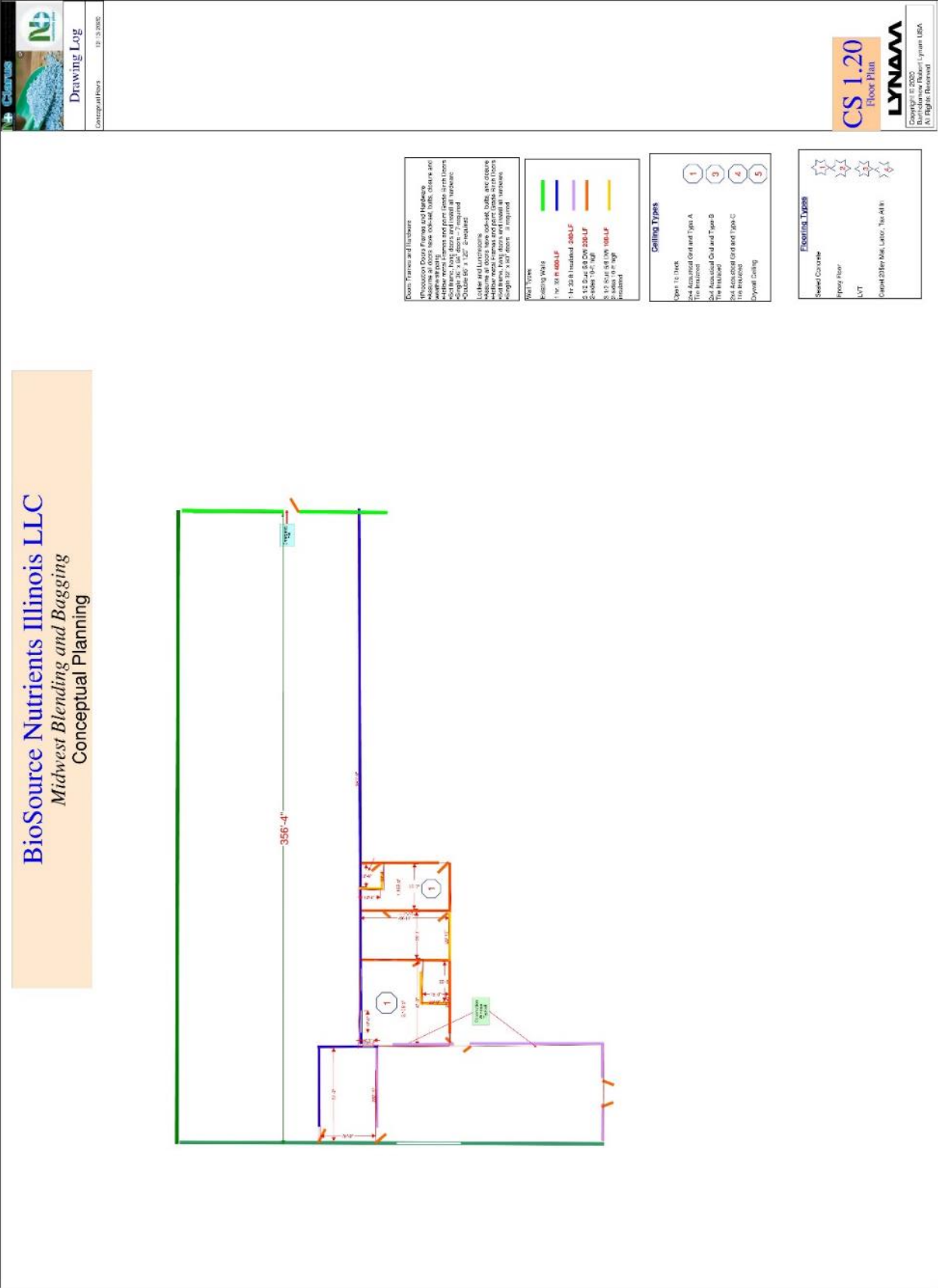

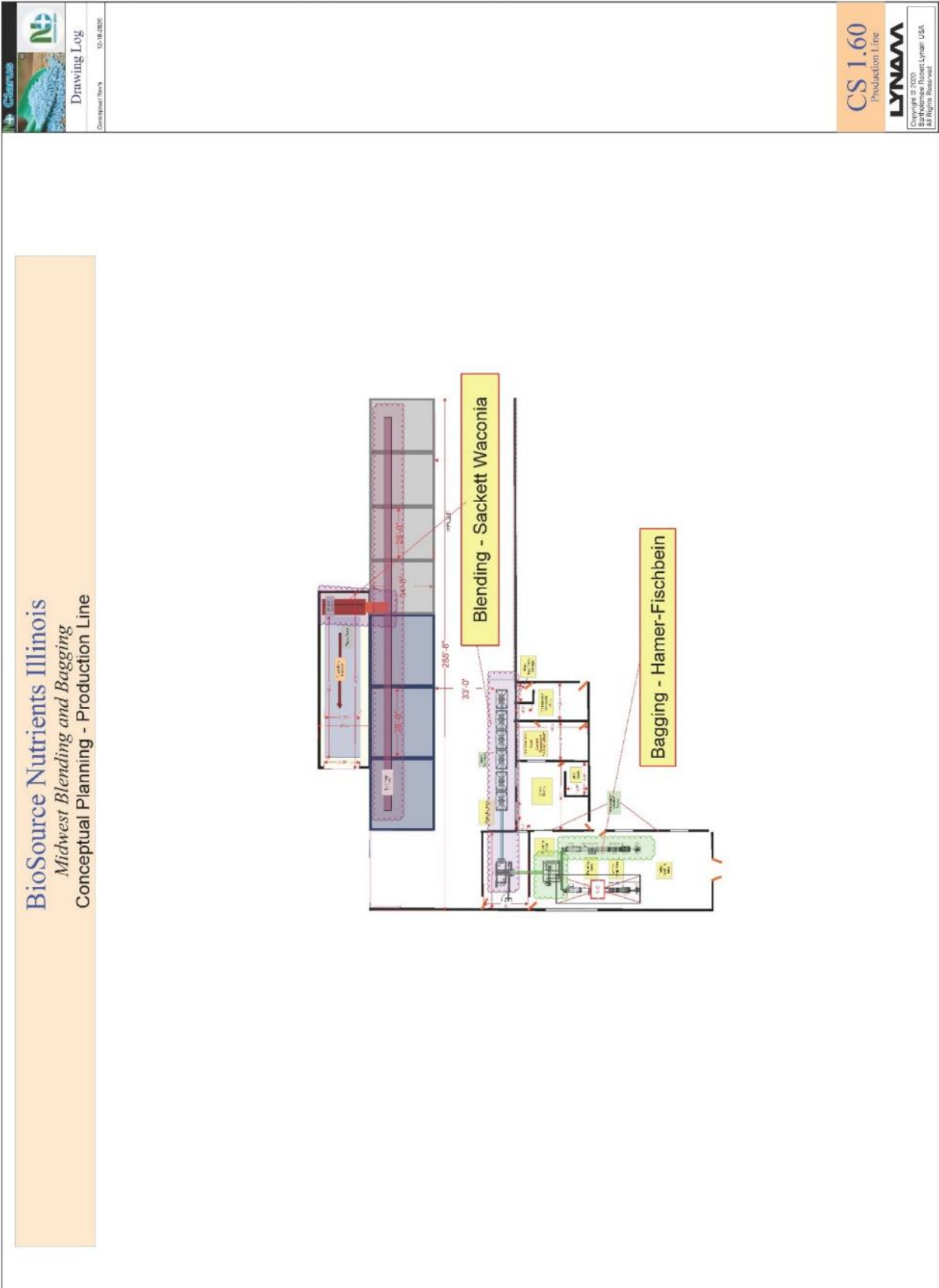

BioSource Nutrients Illinois
Midwest Blending and Bagging
Conceptual Planning - Production Line



Drawing Log
Description: 1/1/15
Date: 11/15/2015

CS 1.60
Production Line
LYNAM
Copyright © 2005
Safford/Robert Lynam USA
All Rights Reserved

BioSource Nutrients Illinois LLC
 Midwest Blending and Bagging
 Conceptual Planning

- Out-Building General Notes**
- 1) Length = 100
 - 2) Width = 30-ft
 - 3) Facade or Skin of Building to be Architectural Metal Panels

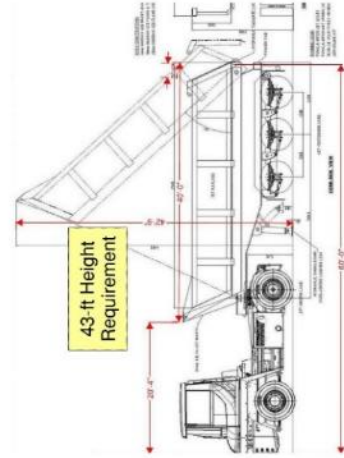
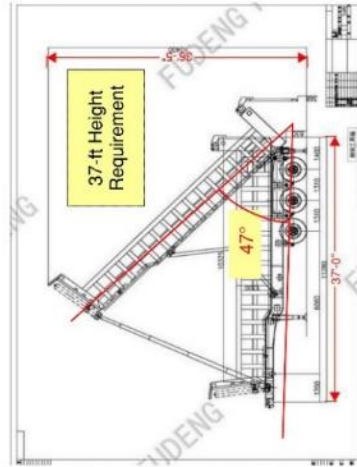
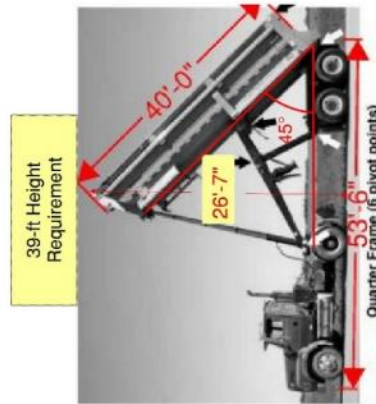
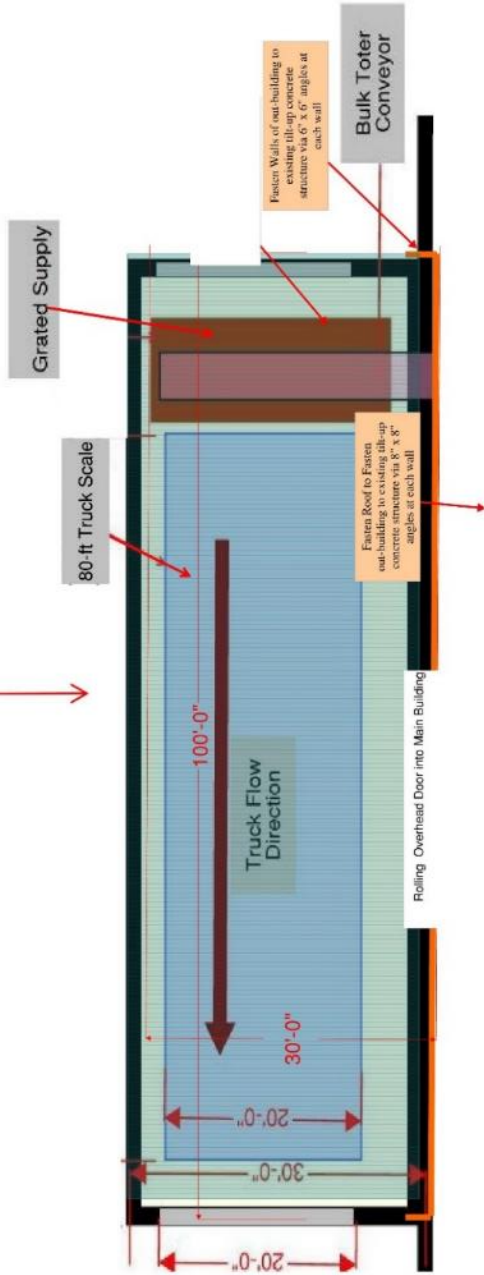

Drawing Log

Original	10-22-2020
Revised	10-22-2020
Revised	10-22-2020
Revised	10-22-2020
Revised	10-22-2020

CS 5.00
 Enlarged Out-Building

LYNAM
 Copyright © 2020
 Manufactured by Lynam USA
 All Rights Reserved

BioSource Nutrients Illinois LLC
 Midwest Blending and Bagging
 Conceptual Planning



Drawing Log
 12-09-2020

CS 5.10
 Out-Building Exterior Elevations
LYNAM
 Copyright © 2020
 Burmester Robert Lynam USA
 All Rights Reserved

- Out-Building Wall Construction**
- A) 1 wall @ 80-linear feet (Alternate @100 Feet), 2-walls @ 30-linear feet
 - B) Framed With 2-in x 6-in x 18-gauge cold rolled framing, insulated.
 - C) Interior Clad to 10-Feet Marine Plywood and tie to the top with 5/8 Moisture resistant Drywall.
 - D) Exterior Framing Clad 5/8 Pressure Treated Plywood
 - E) Exterior Finish Cladding - Architectural Metal Panel
- Roof Construction**
- A) 2-inch x 12-inch manufactured laminated wood Beams
 - B) High-density R-30 Kraft Faced Balis
 - C) Sheath Interior Roof 5/8" Moisture Resistant Drywall

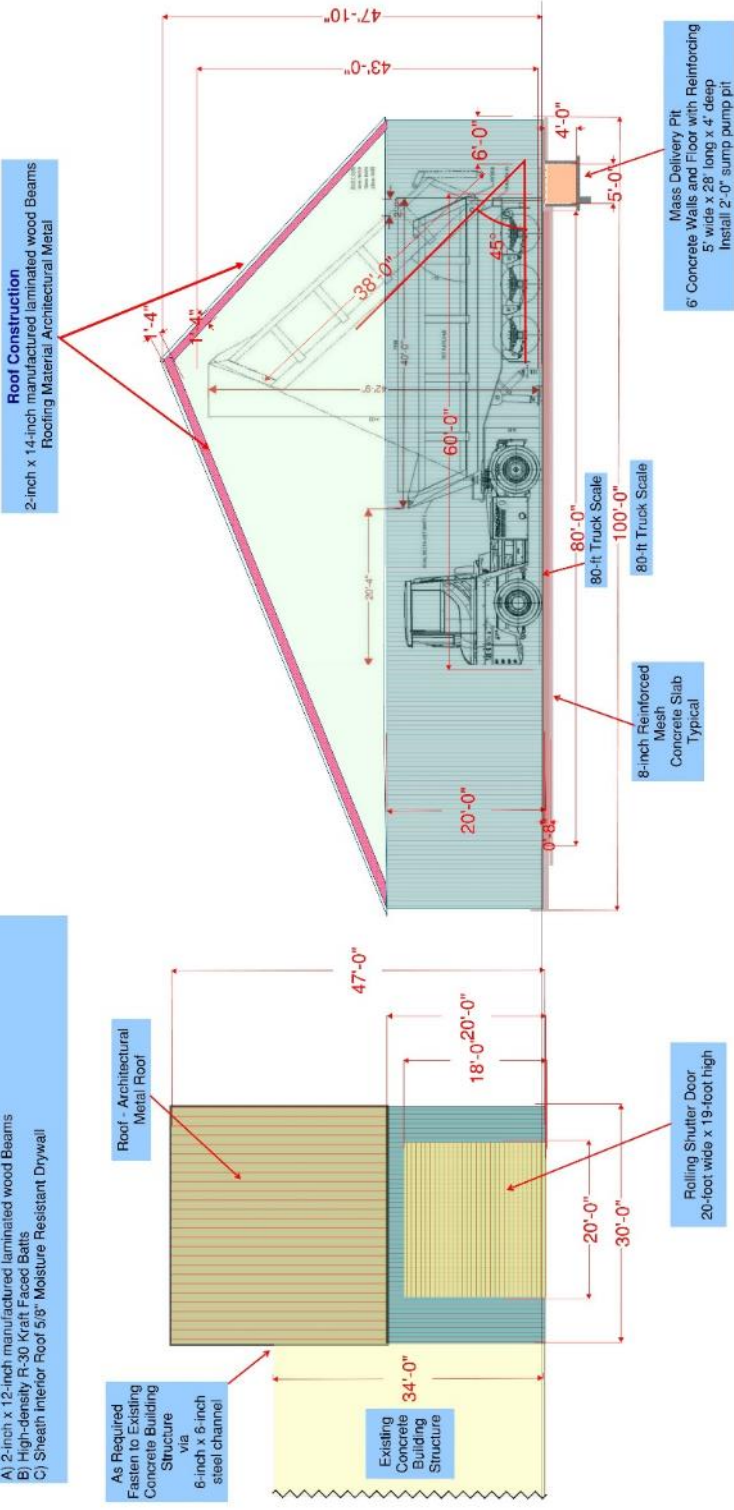

BioSource Nutrients Illinois LLC
Midwest Blending and Bagging
 Conceptual Planning

Drawing Log

Conceptual Review	10/20/2020
Conceptual Plan	10/20/2020
Conceptual Plan	10/20/2020
Conceptual Plan	10/20/2020

Proposed Alterations

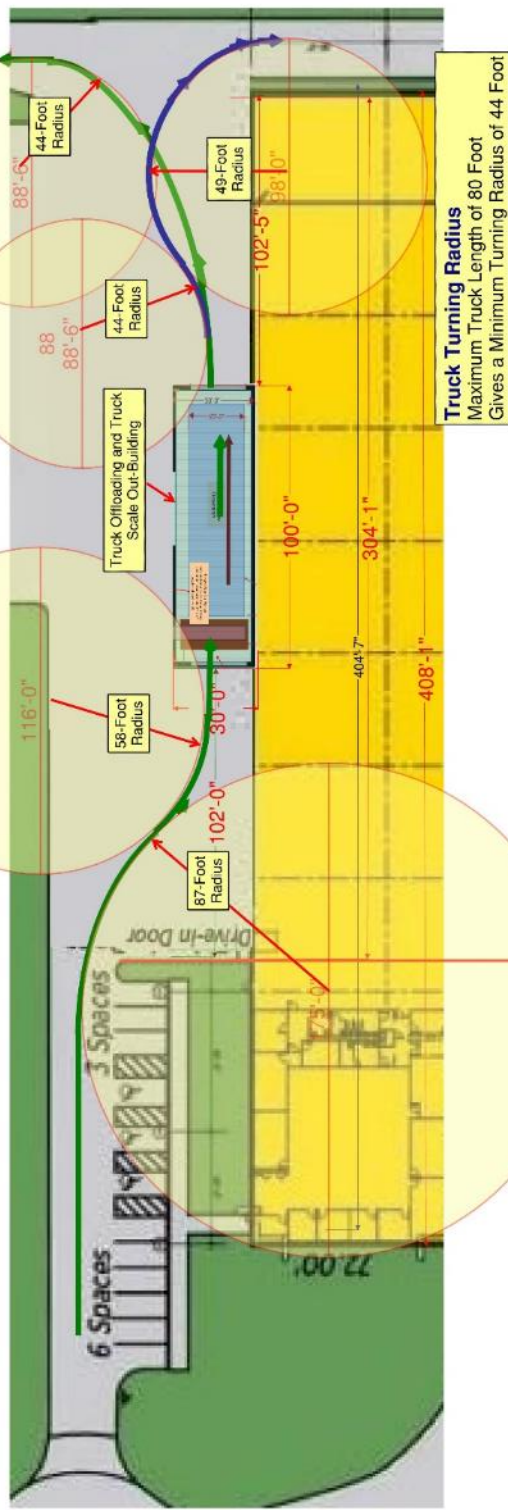

Existing Conditions

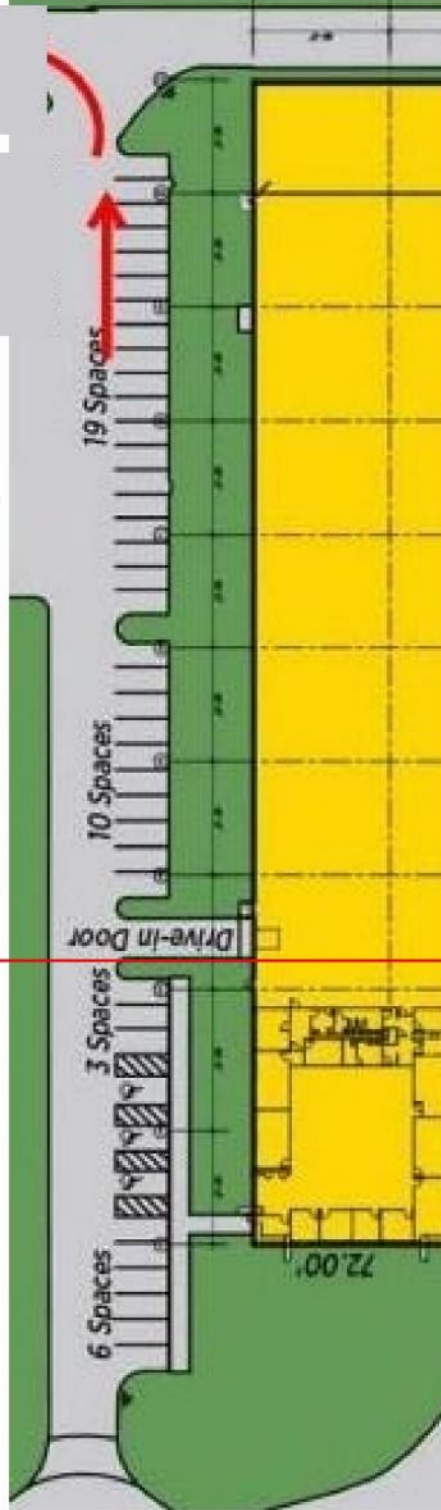

2-Gateway Court
 Bolingbrook, IL
CS 5.20
 Truck Access Out Building
LYNAM
 Copyright © 2020
 Bartholomew Robert Lynam, USA
 All Rights Reserved

CS 5.21 – Out Building Footprint

BioSource Nutrients Illinois LLC
Midwest Blending and Bagging
Conceptual Planning



Drawing Log
Conceptual Review
12-12-2020

CS 5.21
Building and Building
Footprint

LYNAM
Copyright © 2020
Bentley Systems, Incorporated
All Rights Reserved

BioSource Nutrients Illinois LLC
 Midwest Blending and Bagging
 Conceptual Planning



Drawing Log

Created	10-01-2009
Checked	10-01-2009
Approved	10-28-2009
Revised	11-02-2009
Revised	12-07-2009

CS 5.30
 Truck Turning Radius

LYNAM

Copyright © 2003
 Bannockburn, Illinois, USA
 All Rights Reserved

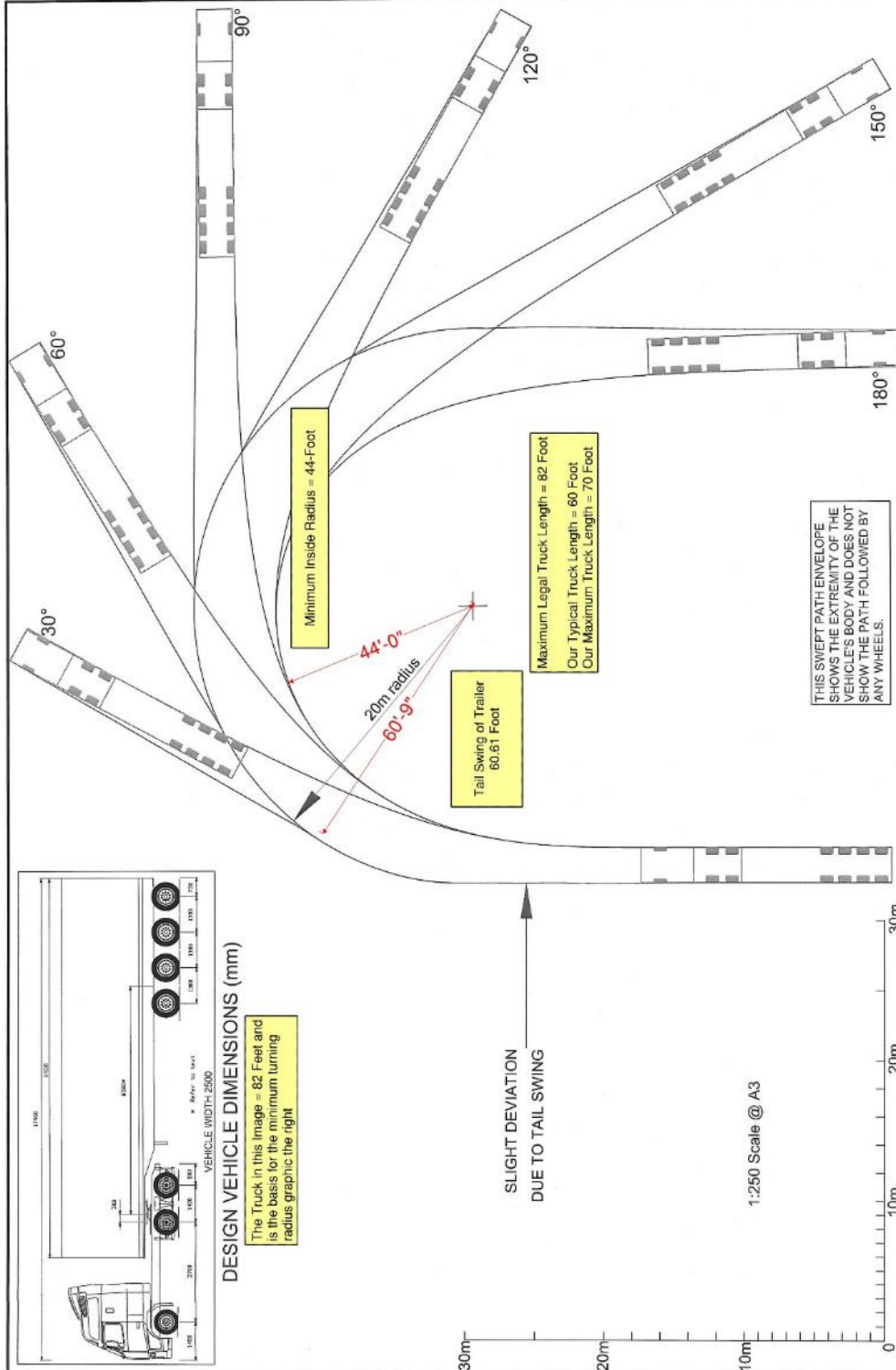

2007 ON-ROAD TRACKING CURVES
 VEHICLE: SEMI-TRAILER
 TURN: 20m RADIUS

Recommended clearances (600mm) must be added to each side of the tracking curve (refer to text)

QUICK REFERENCE

- Semi-trailer
- 1:250
- 20m radius

Sheet 12 of 17

Land Transport NZ
 Ikiiki Whenua Aotearoa

CS-5.40 Out Building Wall Sections and Details



Cleanus
Conceptual Films
12-00-2020







CS 5.50
Out-Building
Roof Materials and Details



Copyright © 2020
Barboursville Robert Lynam USA
All Rights Reserved

<p>STANDARD COLORS</p> 	<p>PREMIUM COLORS</p> 	
--	--	--

 <p>UL 90 SNAP-ON STANDING SEAM</p>	<p>MATERIALS 24 gauge steel* .032 aluminum</p> <p>SPECS 12", 18", 19" or 20" O.C. 1" High</p>	
 <p>UL 90 SNAP-ON BATTEN</p>	<p>MATERIALS 24 gauge steel* .032 aluminum</p> <p>SPECS 11", 12" or 18" O.C. 1-1/2" High</p>	
 <p>UL 90 HIGH SNAP-ON STANDING SEAM</p>	<p>MATERIALS 24 gauge steel* .032 aluminum</p> <p>SPECS 11", 18" or 19" O.C. 1-1/2" High</p>	
 <p>UL 90 TITE-LOC</p>	<p>MATERIALS 24 gauge steel* .032 aluminum*</p> <p>SPECS 12", 18" or 19" O.C. 2" High</p>	
 <p>UL 90 TITE-LOC PLUS</p>	<p>MATERIALS 24 gauge steel* .032 aluminum*</p> <p>SPECS 12", 18" or 19" O.C. 2" High</p>	
 <p>UL 90 SNAP-CLAD</p>	<p>MATERIALS 24 gauge steel* 22 gauge steel*</p> <p>SPECS 10", 12", 16" or 18" O.C. 1-1/2" High</p>	

*1/2" and 1/4" gaps between panels. On Standing Seam panels, 1/4" and 1/2" gaps between panels and underlayment. Underlayment underlayment underlayment and underlayment.

CS-5.50 Out Building Roof Materials



ND
Drawing Log
12-09-2019

Visual Sample of Architectural Metal Wall Panels



CS 5.40
Out-Building
Wall Sections and Details

LYNAM
Copyright © 2019
By Lyman, Robert Lyman USA
All Rights Reserved

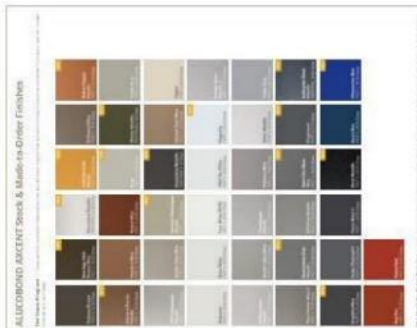

ALUCOBOND PLUS Stock Finishes



ALUCOBOND ACCENT Stock & Made-to-Order Finishes



1. ALUCOBOND PLUS WALL CONNECTION DETAIL



2. ALUCOBOND PLUS WALL CONNECTION DETAIL



3. ALUCOBOND PLUS WALL CONNECTION DETAIL



4. ALUCOBOND PLUS WALL CONNECTION DETAIL





ALUCOBOND PLUS Stock Finishes



ALUCOBOND PLUS Stock Finishes



Existing Building



Alucobond Web Site <https://www.alucobondusa.com/>
Color Charts <https://www.alucobondusa.com/samples.html#>

BioSource Nutrients Illinois LLC
Midwest Blending and Bagging
Conceptual Planning

Conical Frustum Formula in terms of r and h:
Start height of a conical frustum:
 $s = \sqrt{2(r^2 - r_2^2 + h^2)}$
Volume of a conical frustum:
 $V = (1/3) \cdot \pi \cdot h \cdot (r^2 + r_2^2 + r \cdot r_2)$

BioSource Nutrients Illinois
Midwest Blending and Bagging Facility Storage Bin Schedule

Bin Label	Bin Type	Volume (cu yd)	Capacity (cu yd)	Production Capacity (cu yd/week)	Storage (cu yd)	Days of Inventory
Bin Type - 1	32-Ply Marine Plywood	15,500	15,500	15,500	15,500	1
Bin Type - 2	32-Ply Marine Plywood	15,500	15,500	15,500	15,500	1
Bin Type - 3	32-Ply Marine Plywood	15,500	15,500	15,500	15,500	1
Bin Type - 4	32-Ply Marine Plywood	15,500	15,500	15,500	15,500	1
Bin Type - 5	32-Ply Marine Plywood	15,500	15,500	15,500	15,500	1
Bin Type - 6	32-Ply Marine Plywood	15,500	15,500	15,500	15,500	1
Bin Type - 7	32-Ply Marine Plywood	15,500	15,500	15,500	15,500	1
Bin Type - 8	32-Ply Marine Plywood	15,500	15,500	15,500	15,500	1
Total		124,000	124,000	124,000	124,000	1

Midwest Blending and Bagging Facility
Storage Bin Volume Calculator

Bin Label	Note	Number Required	Volume	Total Volume	Total Depth	Width	Height
Bin Type - 1	The 2-ft and 8-ft foot width is a bulkhead wall against the exterior building wall.	4 Required	102.40	409.60	34	28	16.00
Bin Type - 6		5 Required	15,000	75,000	34	38	16.00

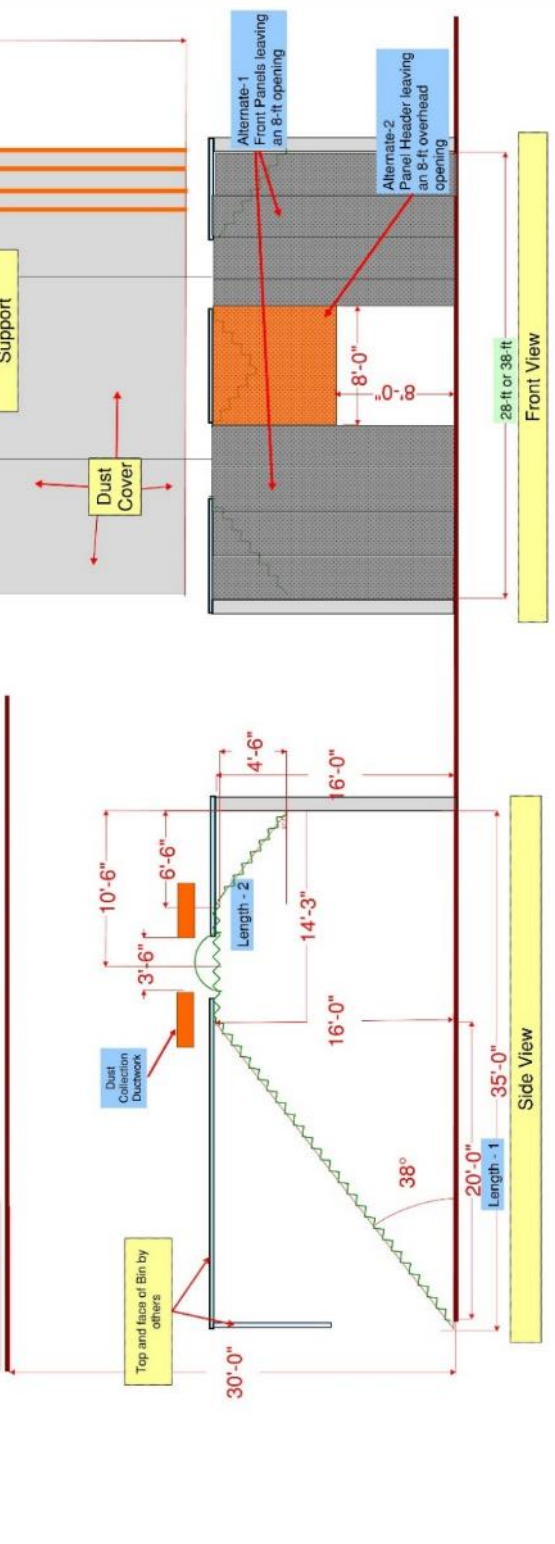

Drawing Log
 15-03-2020
 15-03-2020
 15-03-2020
 15-03-2020
 15-03-2020
 15-03-2020

CS 6.0
 Enlarged Mat. Storage Bin
LYNAM
 Copyright © 2020 Lynam USA
 All Rights Reserved

BioSource Nutrients Illinois LLC
Midwest Blending and Bagging
Conceptual Planning



BRADCO® HIGH-DUMP BUCKET

Part Number	60"	72"	81"	90"
Weight (lbs)	1000	1145	1280	1310
Capacity (cu yd)	1.00	1.18	1.44	1.68
A. Width (in)	60.75	71	81.75	91.5
B. Height (in)	32.28	32.28	32.28	32.28
C. Depth (in)	48.85	49.85	49.85	49.85
D. Backrest (deg)	14°	14°	14°	14°
Pin Spc (in)	1.25	1.25	1.25	1.25
Cylinder Bore (in)	2.8	2.8	2.8	2.8
Cylinder Rod Diameter (in)	1.5	1.5	1.5	1.5

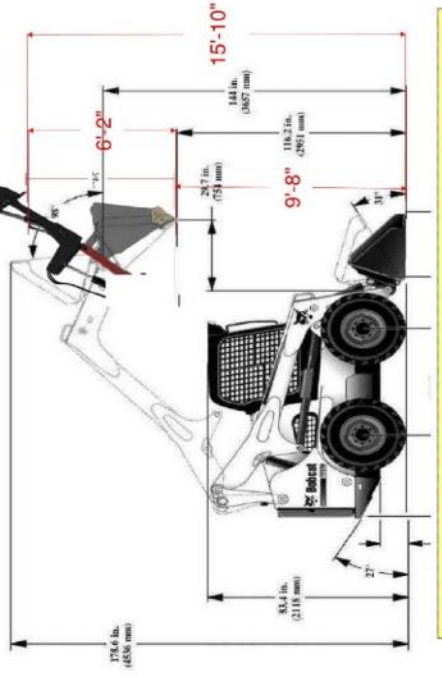
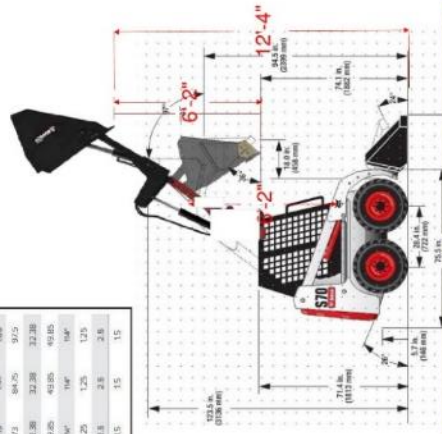
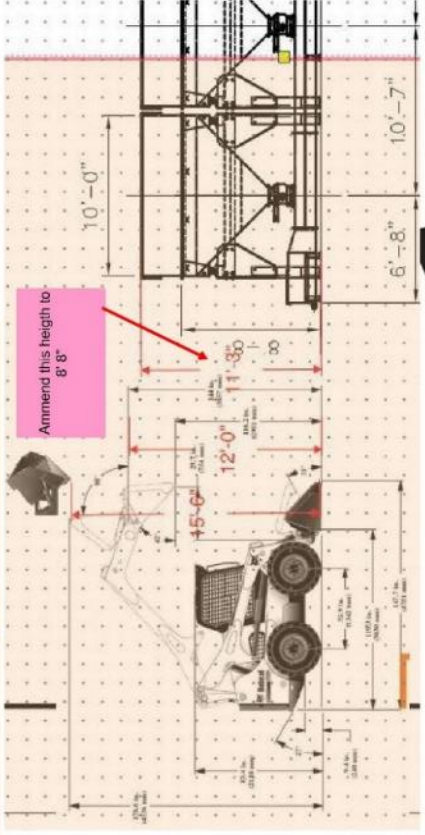
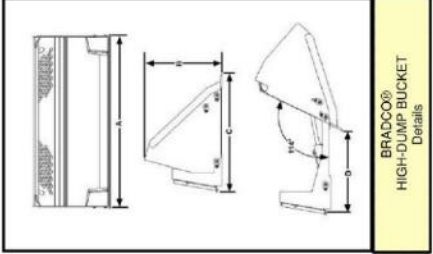

Drawing Log

Conceptual Review	10-02-2020
Conceptual Revs	10-02-2020
Conceptual Drawing	10-02-2020
Conceptual Revs	10-02-2020



CS 8.0
Enlarged Mat. Storage Bin

LYNAM
Copyright © 2020 Lynam USA
All Rights Reserved

BioSource Nutrients Illinois LLC

Midwest Blending and Bagging

Conceptual Planning



Design Intent
Utilize Narrow Isle Forklift



Design Intent
Utilize Narrow Isle Forklift

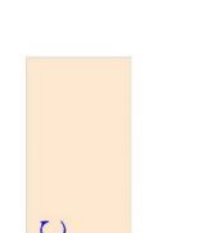

Clear Ceiling Height

Design Intent
30' 0" Clear Ceiling Height
5-Pallets Tall
36" Pallet Height = 20-ft high racking system
40" Pallet Height = 21'-9" High Pallet Racking System

Design Intent
Narrow Isle Racking System @ 8'-0" Isle Width
Back-to-Back system and Single @ perimeter walls

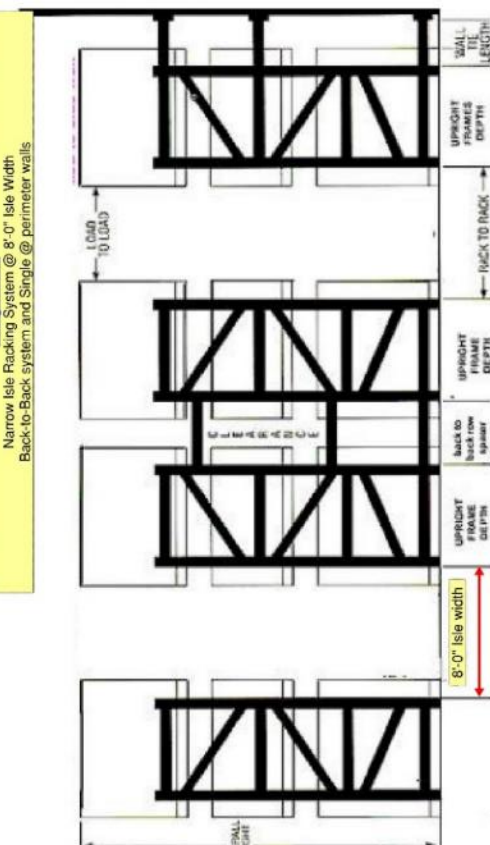

Labels: UPSPRIGT CLEARANCE DEPTH, RACK TO RACK, RACK TO RACK, UPSPRIGT FRAME DEPTH, WALL LENGTH, RACK TO BACK WALL CLEARANCE LENGTH, LOAD TO LOAD, 8'-0" Isle width, PERIMETER WALL LENGTH.

Design Intent
Utilize a Tunnel Isle Design

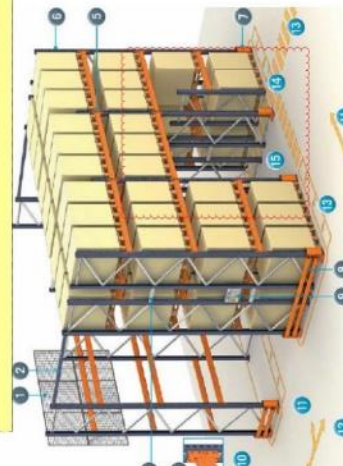

Labels: Circulation and maneuvering aisle, Tunnel aisle, Working aisle, Single entry alignment, Sorting and dis area, Double entry alignment.

Design Intent
Utilize Wire Deck or Other Clear Substrate and Pallet Support Beams
For Fire Sprinkler Free Flow of Water

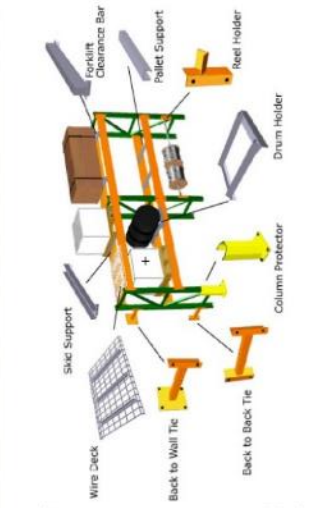

Labels: Wire Deck, Back to Back Tie, Back to Back Tie, Pallet Support, Reel Holder, Drum Holder, Column Protector, Forklift Clearance Bar, Side Support.

Design Intent
Utilize Wire Deck or Other Clear Substrate and Pallet Support Beams
For Fire Sprinkler Free Flow of Water

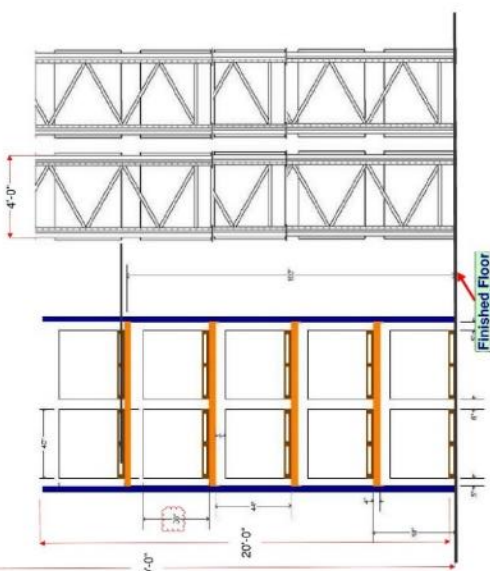

Labels: UPSPRIGT CLEARANCE DEPTH, RACK TO RACK, RACK TO RACK, UPSPRIGT FRAME DEPTH, WALL LENGTH, RACK TO BACK WALL CLEARANCE LENGTH, LOAD TO LOAD, 8'-0" Isle width, PERIMETER WALL LENGTH.

CS 9.0.00
Pallet and Racking

LYNAM
Copyright © 2020
Barrington, Robert Lynam USA
(All Rights Reserved)

BioSource Nutrients Illinois LLC
Midwest Blending and Bagging
Conceptual Planning

Design Intent
40-Bags per skid and 50-Pounds per bag = 2000-pounds per skid
A Pallet is 40"-Wide x 48"-Deep x 40"-High

Width _____
Depth _____
Height _____

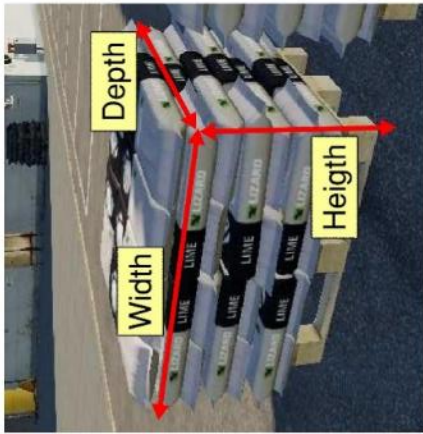

Design Intent
2-way Pallet design and Components
Pallet Dimension 40" x 48" x 5.38"

Side View

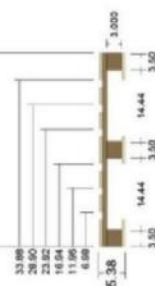

End View



Top View

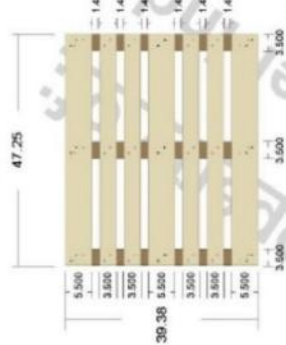

Bottom View

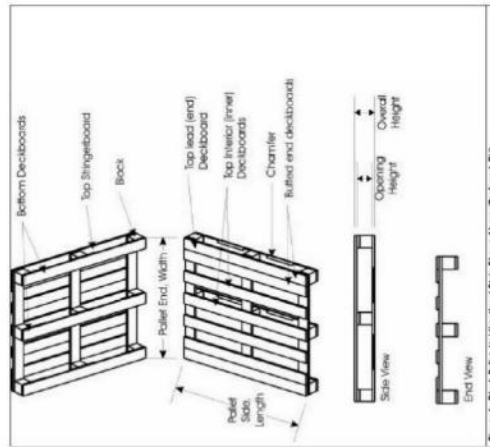
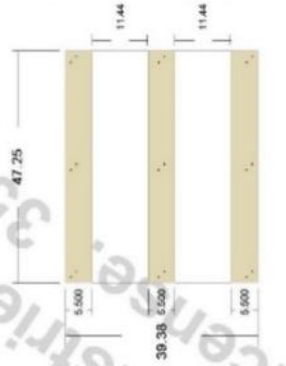

Figure 1. Block Pallet, Underside View (Show Above Elements, EU)

CS 9.10
Pallet and Racking

LYNAM

Copyright © 2020
Lynam, Robert Lynam USA
All Rights Reserved

Drawing Log

12-03-2020	Conceptual Review
10-28-2020	Conceptual Review
10-28-2020	Conceptual Review
12-02-2020	Conceptual Review



BioSource Nutrients Illinois LLC
 Midwest Blending and Bagging
 Conceptual Planning

- "Flood Feed" inlet for truck, with 5'-0" x 10'-0" intake, and heavy duty drive over grate - pit, pit design, sump, and additional coverage by others

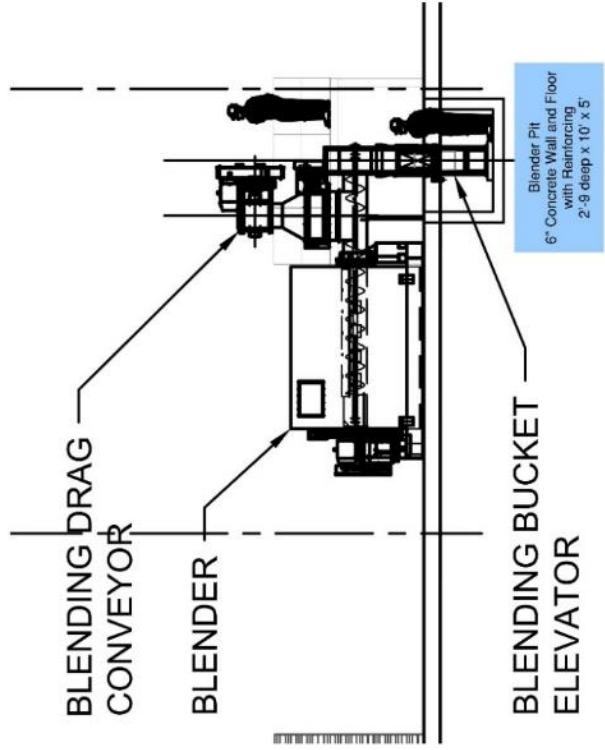
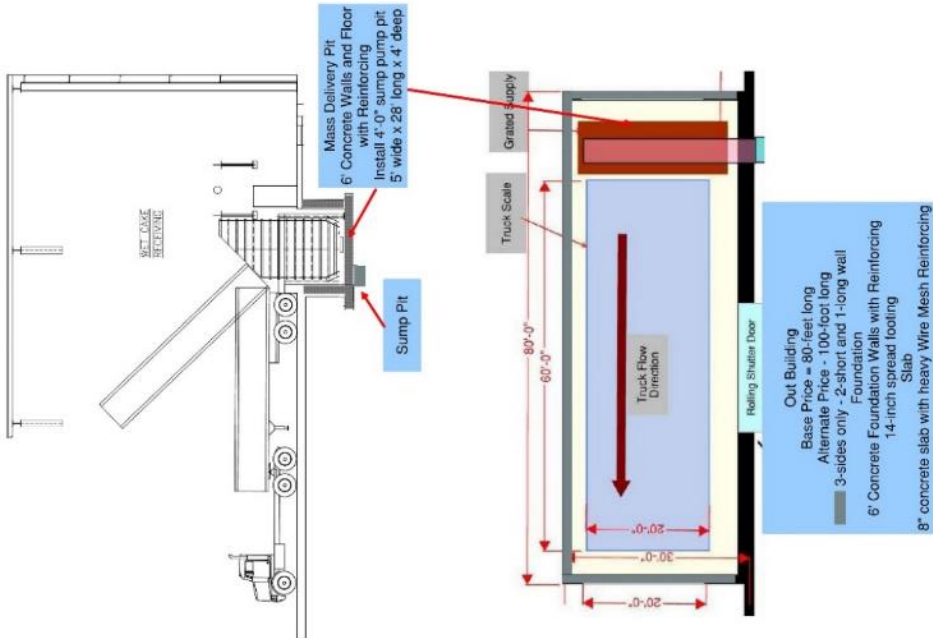

Drawing Log

Conceptual Review	10-23-2020
Conceptual Review	10-29-2020
Conceptual Review	11-10-2020
Conceptual Drawing	11-3-2020
Conceptual Review	11-17-2020

CS 10.00
 Concrete Details

LYNAM
 Concrete Details
 Copyright © 2020
 Lynam Construction, LLC
 All Rights Reserved

CS M1.0 - HVAC Floor Plan

BioSource Nutrients Illinois LLC
 Midwest Blending and Bagging
 Conceptual Planning

	Drawing Log
	Conceptual Review: 10-20-2020
	Conceptual Rev #1: 10-29-2020
	Conceptual Rev #2: 11-02-2020
	Conceptual Rev #3: 12-07-2020

CS M1.00
Mechanical Layout

LYNAM
 Copyright © 2020
 Barrington, Robert Lynam, USA
 All Rights Reserved

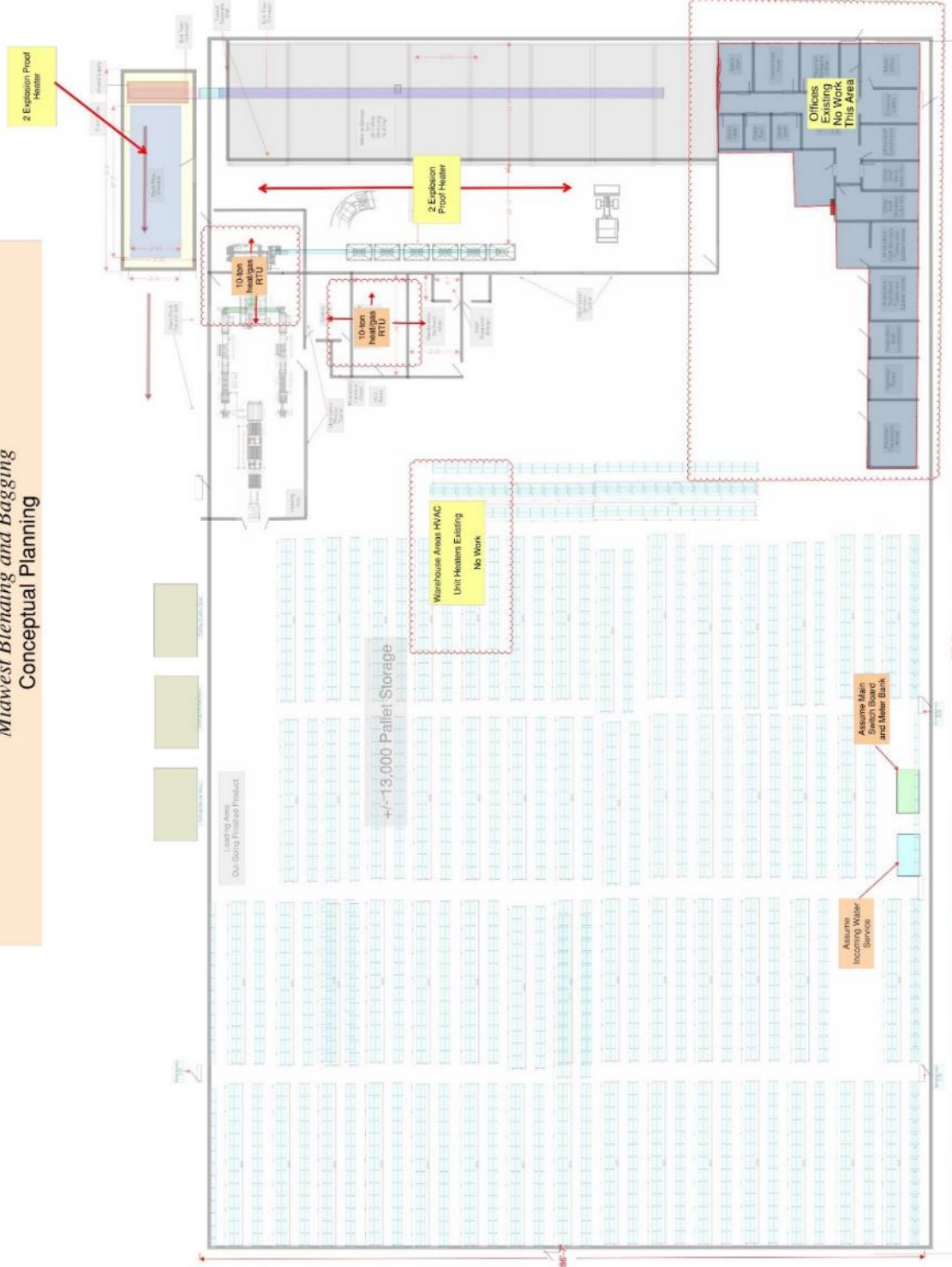

BioSource Nutrients Illinois LLC
Midwest Blending and Bagging
Conceptual Planning



- Considerations for Conceptual Dust Control Criteria**
LEL for each gas has been determined to be between 4.5 and 10 percent.
- Sources of Ignition**
Electrostatic discharge - Integrate installed conveyor belt, which can act as a VFD, DC Drive generator.
- Protein**
Electrical wiring, open machinery or other equipment hot surfaces for all compressed airways.
- Flare**
- Start-up/Shutdown**
- Site-Zone Air Quality and Other Control Totals**
- Zone 1 Moving Storage Hopper Area 150CFM
 - Zone 2 Over Side Hoppers 75 CFM
 - Zone 3 Hopper
 - Zone 4 Moving Blending Dangle 150CFM
 - Zone 5 Blending Area 100CFM
 - Zone 6 Bagging Area 80 CFM
 - Return Air
 - VFD Control Per Zone and Storage Hopper
 - Other Sources: vertical packed tower, Hoppers, one end and one side
 - Bag House Dust Collection

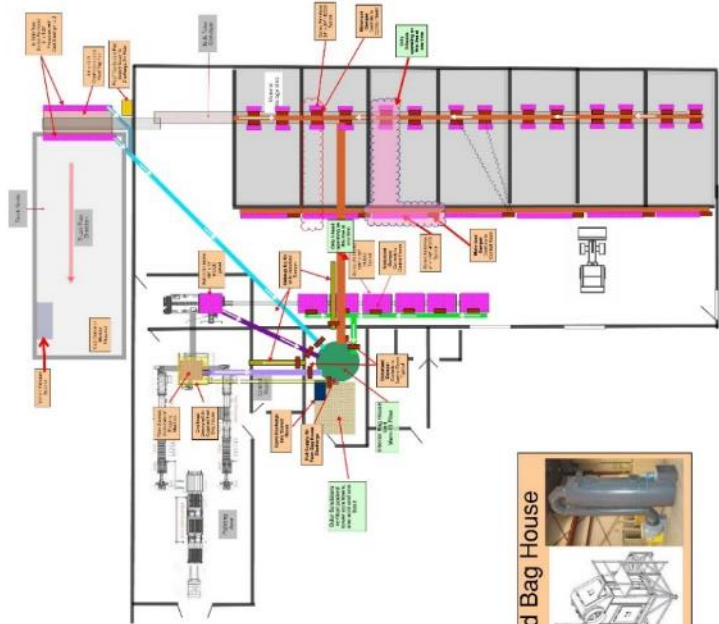

Conceptual Air Scrubbers And Bag House



Drawing Log

Conceptual Review	10/01/2020
Final Review	10/01/2020
Conceptual Revs	10/28/2020
Conceptual Revs	11/25/2020

CS M2.00
Ductwork, Dust and Odor Control



BioSource Nutrients Illinois LLC
 Midwest Blending and Bagging
 Conceptual Planning

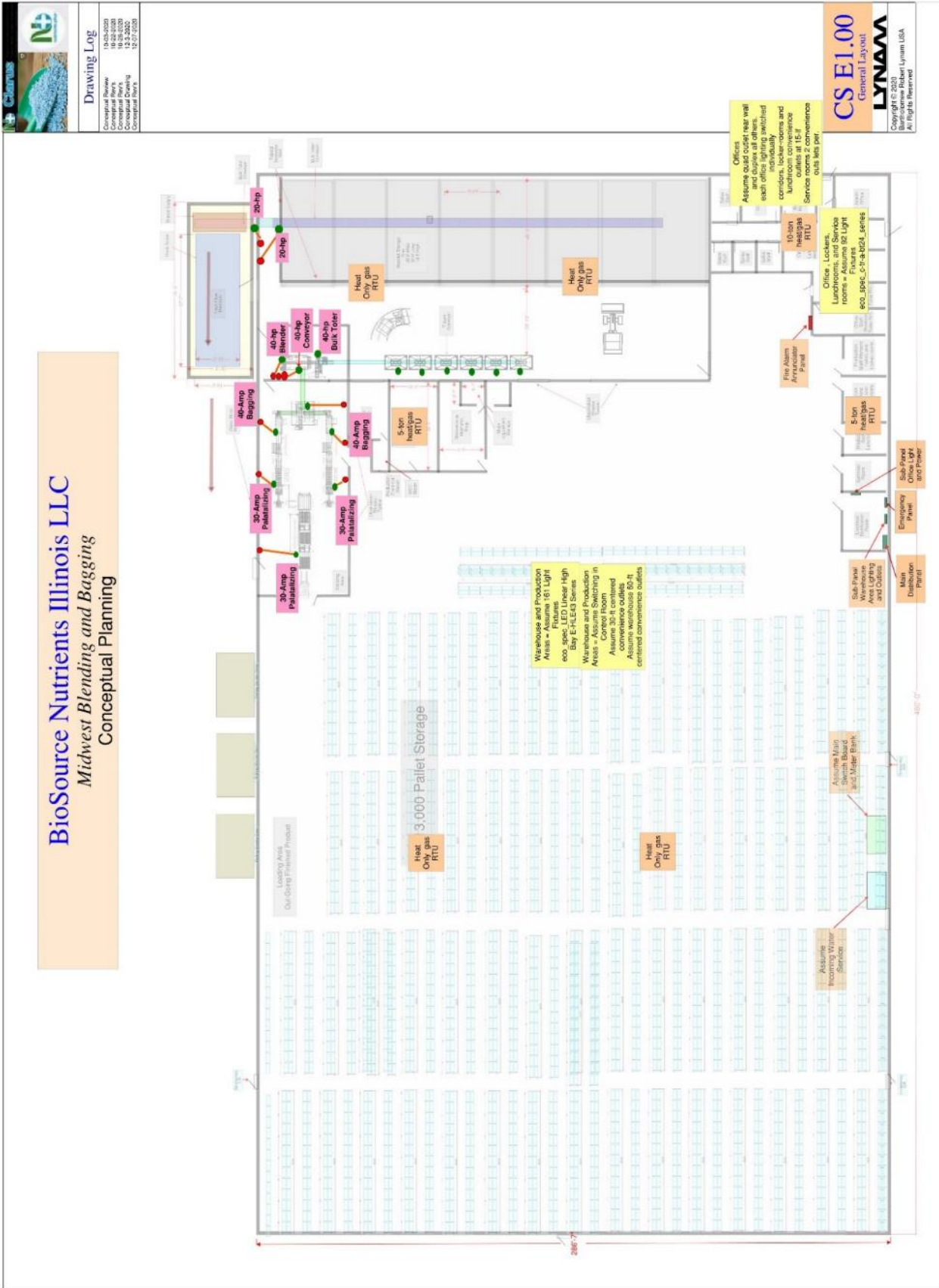

Drawing Log

10-22-2020	Conceptual Review
10-22-2020	Conceptual Review
10-22-2020	Conceptual Review
12-02-2020	Conceptual Review

CS E1.00
 General Layout
LYNAM
 Copyright © 2020 Lynam USA
 All Rights Reserved

BioSource Nutrients Illinois LLC
 Midwest Blending and Bagging
 Conceptual Planning



Drawing Log	
Conceptual Review	10/03/2020
Conceptual Review	10/03/2020
Conceptual Review	10/03/2020
Conceptual Review	10/03/2020
Conceptual Review	10/03/2020
Conceptual Review	10/03/2020
Conceptual Review	10/03/2020

CS E2.00
 General Layout

LYNAM

Copyright © 2020
 Bartholomew Project, Lynam USA
 All Rights Reserved

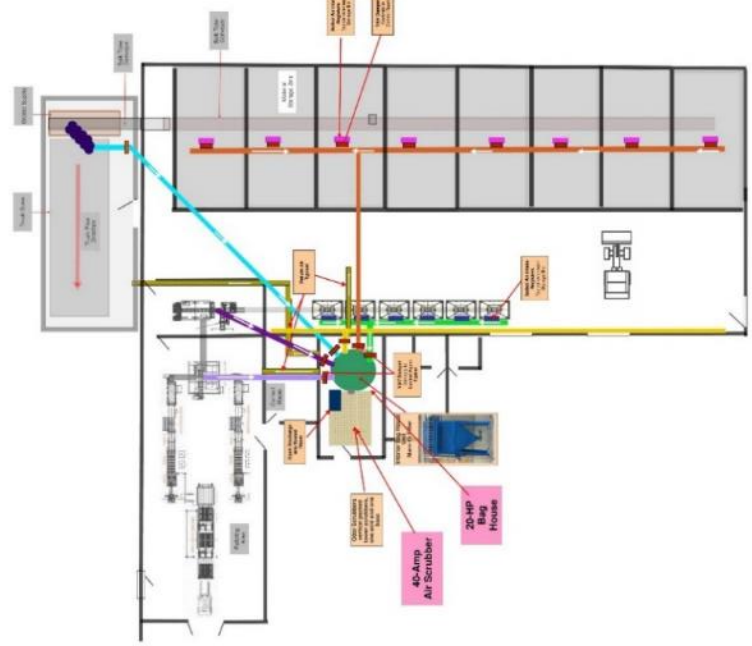

Considerations for Conceptual Dust Control Criteria

L.E.I. for woodst has been determined to be between 10 and 50 grains/m³

Series of ignites

Electrostatic discharge: improperly installed conveyor belt, worn rollers, or a V-belt on a motor generator

Friction

Electrical arcing from machinery or other equipment hot surfaces (e.g. overheated bearings)

Flux

Self ignition

- Six-Zone Air Quality and Odor Control**
- Zone 1 Internal Storage Hopper Area
 - Zone 2 Over Scale Hoppers
 - Zone 3 Floor Level Scale Hoppers
 - Zone 4 Material Receiving Garage
 - Zone 5 Inventory Area
 - Zone 6 Bagging Area
 - Mature Air
 - MAV Control Piv Zone (air)
 - Storage Hopper
 - Over Storage: vertical packed tower scrubbers, wet cyclone and filter
 - Bag House Dust Collection

BioSource Nutrients Illinois LLC
Midwest Blending and Bagging
Conceptual Planning

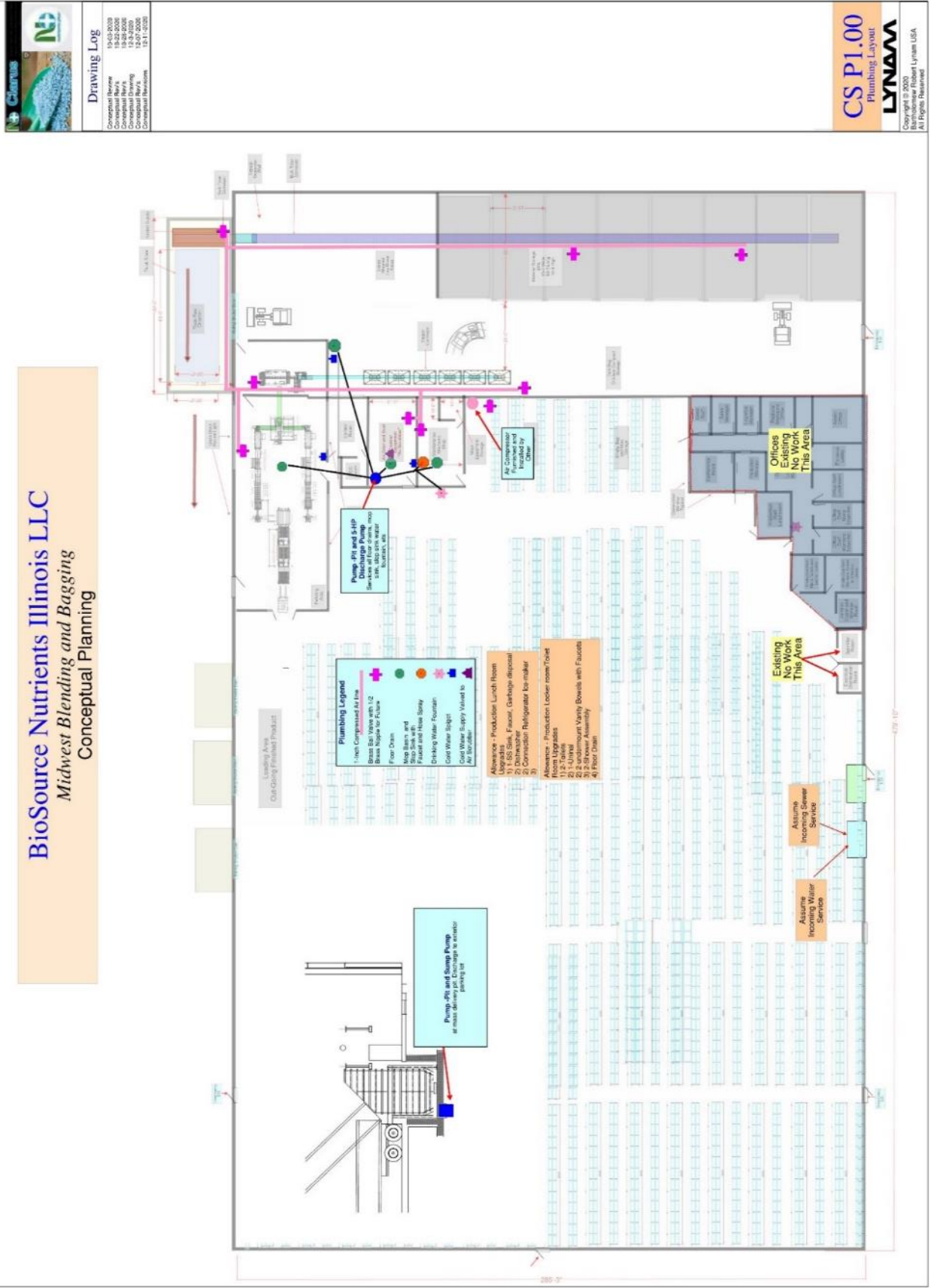

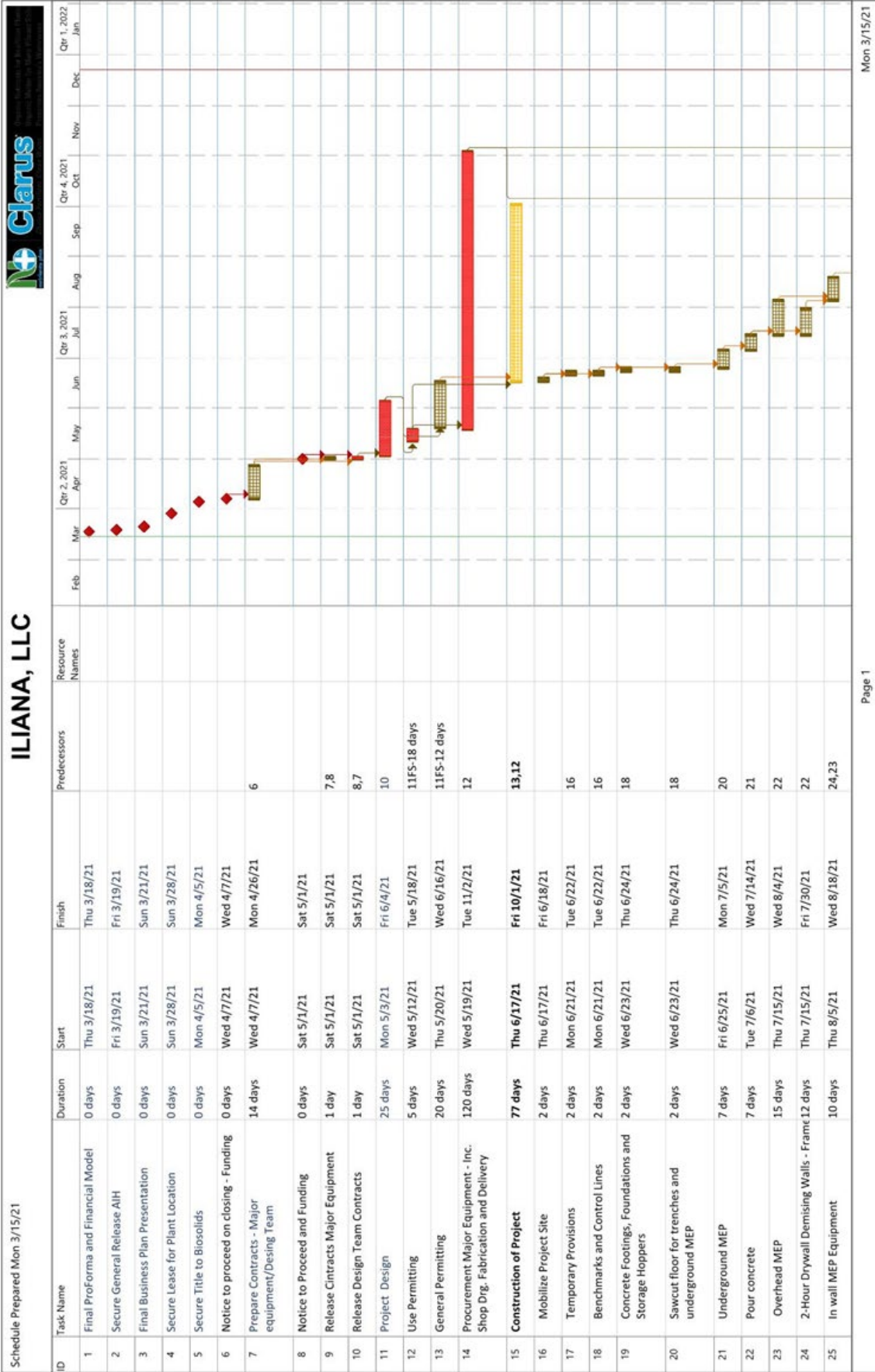

ILIANA, LLC

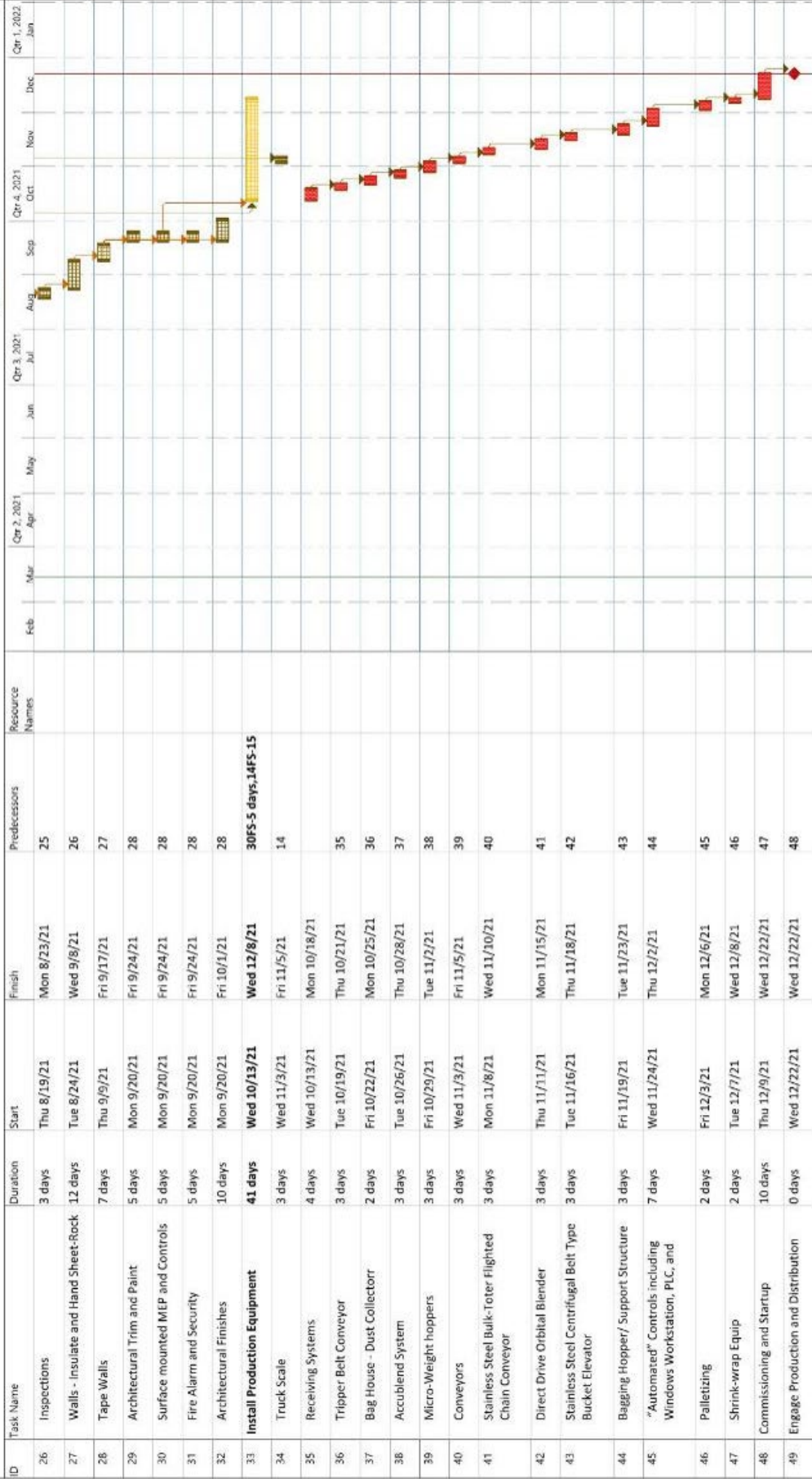

Exhibit - E Safety

Safety – Design and Construction

[Click here for sample Safety Manuals](#)

Some General Good Practice Guidelines:

- Follow OSHA Construction Practices
- Supervisors must be OSHA-30 certified
- Engage in weekly team Safety meeting with the foreman from each subcontractor present\

Safety - During Normal Operations

[Click here for sample Safety Manuals](#)

Some General Good Practice Guidelines:

- Purchase a Warehouse Safety Guide can be purchased for between \$100 and #250
- Each Production Shift to have an assigned “Assistant Production Manager” on staff to manage the shift.
- The production staff and associated managers to engage and document weekly safety meetings. These meeting require a sign-in sheets, documentation of topics covered, and digitally archived.

Skid Steer – Safety

All Skid Steer operators require OSHA certification with annual renewals.

Forklift – Safety

All forklift operators require OSHA certification with annual renewals.